

■ Operation Manual for AMS-2000

# ALKAMEDI

DIGITAL WATER IONIZER

A decorative graphic consisting of numerous thin, curved lines that sweep across the page from the left side towards the right, creating a sense of motion and depth. The lines are more densely packed in some areas, creating a gradient effect.

- ① Read for safety
- ② Appearance and Functional Structure
- ③ Installation and Supplies
- ④ How To Operate
- ⑤ Filter Replacement and Filter Composition
- ⑥ pH Test
- ⑦ Utilization of Ionized Water
- ⑧ Troubleshooting
- ⑨ Unit Specifications
- ⑩ Warrantee Card

Make sure to read this manual to correctly use the unit,  
Keep the manual in an easy-to-find place for anytime reference.

※ Make sure to read the followings for your safety and property protection.



Warning of a possible serious danger such as an injury or fire in case an user does not follow, or important information.



Caution against a possible wound or physical damage etc.

Note the followings before drinking of ionized water



Drink after consulting with a doctor or pharmacist in such case as the followings.

- In case an alkaline water drinking gives abnormal physical condition.
- In case a continuous drinking does not give improvement of stomach symptoms.
- If anyone is under doctor' treatment, of physical trouble or of physical abnormality.
- In case of patients of renal failure such as potassium-excretion disorder etc.



For better drinking

- Waste a cup of alkaline water obtained at the beginning of machine' s operation before drinking.
- For a beginner, drink small amount of it at low alkalinity pH (pH level 1), thereafter gradually more amount and higher pH.
- Do not take a medicine with alkaline water.
- For continuous drinking of it, check the pH strength of it once a month to confirm the given pH value within a drinkable range.
- Recommend 500ml~1,000ml / day as an optimum drink amount.
- Ionized alkaline water helps improve a stomach trouble such as chronic diarrhea, indigestion, abnormal fermentation in a stomach and hyperacidity.
- pH 9,5 level is optimum and higher than pH 10 should be avoided.
- Keep in a closed container, but drink it as soon as generated from the unit.

## ① For electrical safety



When an unit main body is dropped into water, pull off the power plug immediately and take the unit body out of water.

- ▶ Otherwise it may cause an electric shock.



Avoid an electric circuit overload of an outlet or electric wiring. Connect the unit power plug to the correspondent AC voltage outlet.

- ▶ If electric overload thereon due to too many connections, it may cause a fire by an overheating thereon.



Do not touch the power plug with the wet hands when you put it in or off a wall outlet.

- ▶ Otherwise, it may cause an electric shock.



Completely plug in the power cord for stable fitting.

- ▶ If the plug-in fitting is not stable, it may cause an electric shock or fire by overheating thereon.
- ▶ Do not use a damaged plug or unstable wall outlet.

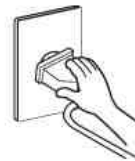

If the supplied cord is damaged, it must be replaced by the manufacturer, it's service agent or qualified persons in order to avoid a hazard.

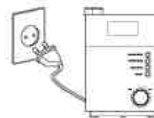

## ② For stable installation



Do not install an unit in the place of below-freezing temperature or near any fire source.

- ▶ Proper circumference temperature: 10 ~ 35° C
- ▶ Proper inflow water temperature: 5 ~ 30° C

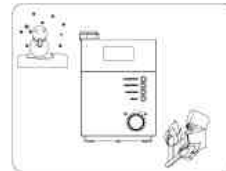

Do not install an unit in direct sunlight.

- ▶ Otherwise, it may cause a twisted or decolorized unit body.

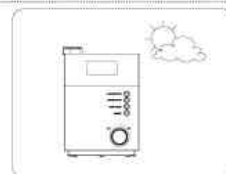

Install an unit on horizontally flat surface. Do not place any heavy thing on the top of an unit.



③ Note the followings while an unit is operated

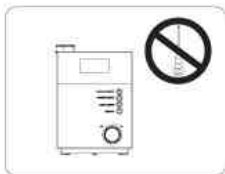

Do not disassemble, repair and/or modify in any case.

- ▶ Otherwise, it may cause a fire or electric shock,
- ▶ For repair, please contact our sales agent,

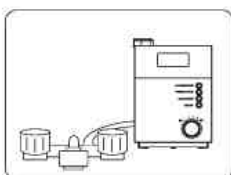

Do not use any other water than sanitarly drinkable safe water (municipal water etc).



Let the unit have water input and output for 2 ~ 3 minutes before the 1st hand operation of the unit after installation in order to have unit' s optimum operation condition.

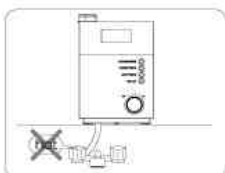

Never allow hot water input into an unit. Otherwise, an unit will have a severe damage to its interior part, especially filter and ionization chamber.

- ▶ Optimum input water temperature: 5 ~ 30° C.



Never spray an unit with water, nor clean an unit with water or other liquid.

- ▶ Otherwise, it may cause electric leakage or unit disorder.



Do not clog, bend, twist or kink the water input and output hoses.

- ▶ Unit breakage or leakage may cause a disorder or different pH value water generation.



## ④Others



Do not place the pH test reagent / liquid near an open flame.

- ▶ Otherwise it may cause a fire due to ignition of pH test reagent.



화기금지



Do not use an Aluminum (weak against alkaline liquid), copper (weak against acid) or other metallic receptacle to store ionized water.

- ▶ A metal receptacle makes ionized water lose its properties.
- ▶ None corrosion receptacles such as glass, polyethylene or ceramic are recommended.

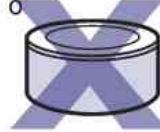

Do not drink ionized or purified water being stored for a longer time over 3 days.

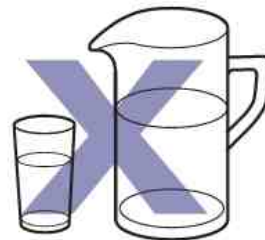

Do not drink, put in the eyes or apply on the body the pH test liquid

- ▶ In case of accidental drink of the test liquid, induce vomiting and call a doctor immediately.
- ▶ In case eyes are touched with it, wash it off with clean water, and call a doctor.
- ▶ In case skin is touched with it, wash it off with water.
- ▶ Keep the pH test liquid kit out of children's reach.

FRONT FACE

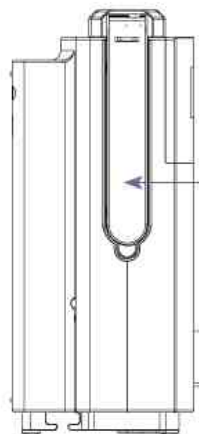
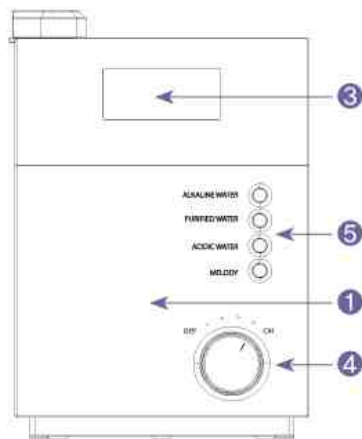

- 1 Front Side.
- 2 Alkaline Water Outlet Nozzle,  
→ Alkaline ionized water comes out.
- 3 LCD Screen (Function Indicator)  
→ It indicates an operation condition.
- 4 Water Supply Valve.
- 5 Control Buttons.

BACK FACE

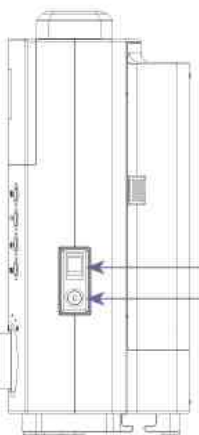
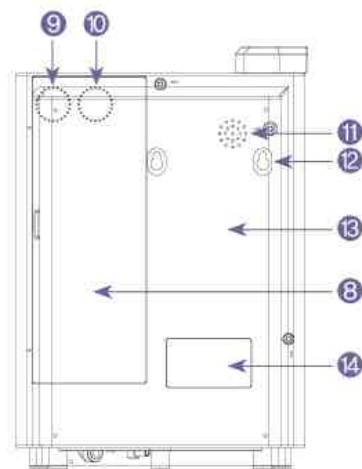

- 6 Main Power Switch.
- 7 Fuse Holder.
- 8 Filter Cover.
- 9 Filter Connection Terminal,  
→ A filter cartridge must be connected to the terminal when the filter is replaced with a new one.
- 10 Reset Button,  
→ The filter life reset button may not be available according to unit' s function performance.
- 11 Speaker.
- 12 Holes for Wall-mount.
- 13 Back Side.
- 14 Label.

FOOT FACE

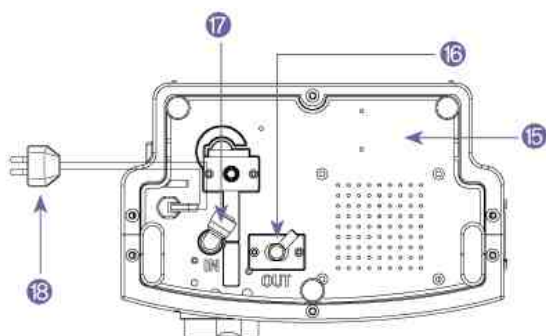

- 15 Foot Side.
- 16 Acidic Water Outlet Port,  
→ Acidic water comes out.
- 17 Water Inlet Port,  
→ Connect with a water supply hose.
- 18 AC Power Code.

## LCD SCREEN (Function Indicator Window)

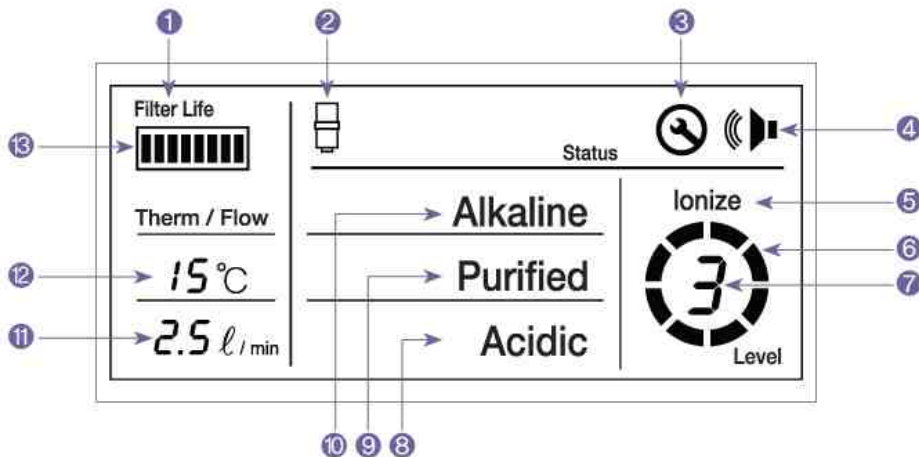
**1. Filter Life Indicator.**

→ It lets an user know the timing of filter replacement,  
Replace filter when it flickers.

**2. Filter Authenticity Indicator.**

→ It is to identify the filter authenticity.  
It flickers when an authentic filter is not used.

**3. Checkup Icon.**

→ It flickers when an unit is disordered.

**4. Voice Icon.**

→ It indicates the voice function does work,  
An unit tells what function an user selected.

**5. Ionization.**

→ It indicates the process of ionization.

**6. Water Inlet Indicator.**

→ It rotates (swirls) when water flows into an unit.

**7. pH level Indicator.**

→ It indicates a selected pH level.

**8. Acidic Water Choice Indicator.**

→ It indicates the choice of acidic water.

**9. Purified Water Choice Indicator.**

→ It indicates the choice of purified water.

**10. Alkaline Water Choice Indicator.**

→ It indicates the choice of alkaline water.

**11. Water Inflow Rate Indicator.**

→ It shows the water inflow rate.

**12. Inlet Water Temperature Indicator.**

→ It shows the temperature of inflow water.

**13. Filter Life Icon.**

→ It indicate the remnant of a filter life.  
The sticks disappear from the left side.

## CONTROLLER PANEL

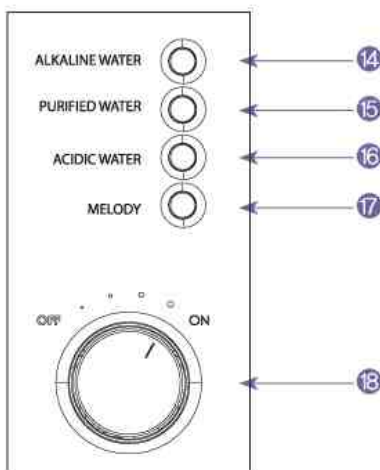
**14. Alkaline Water Button**

→ Push the button to choose alkaline water output.

**15. Purified Water Button**

→ Push the button to choose purified water output.

**16. Acidic Water Button**

→ Push the button to choose acidic water output.

**17. Melody Button.**

→ The melody plays when the acidic water output mode is chose, but the melody does not play when the button is pushed.

**18. Water Supply Valve.**

→ To start / stop the unit operation by opening / closing the valve and to adjust water inflow rate.

VIEW OF AN INSTALLED UNIT

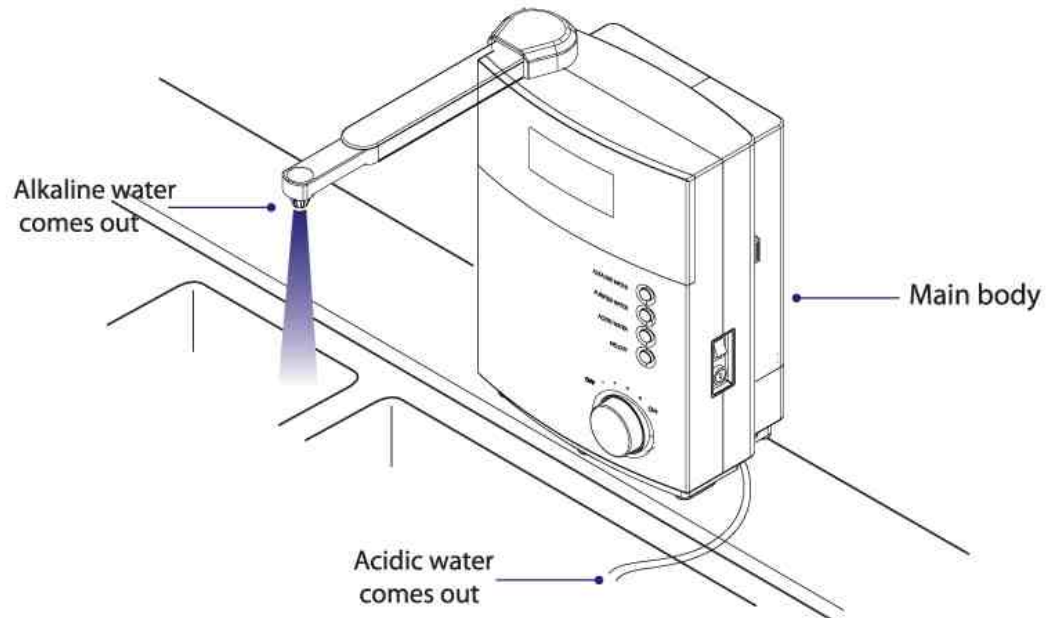

WALL- MOUNT INSTALLATION

- ① Vertically attach the provided installation-guide paper on the intended location of the wall after slightly pasting the guide paper with water.

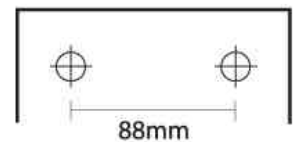

- ② Drill holes into the wall on the wall stud position as shown in the guide paper and insert the screw holders. Screw down the studs into the screw holders (1 cm length of the studs over the wall surface is needed).

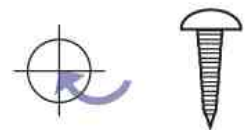

- ③ Mount an unit on the wall, inserting the wall studs into the backside holes of an unit.

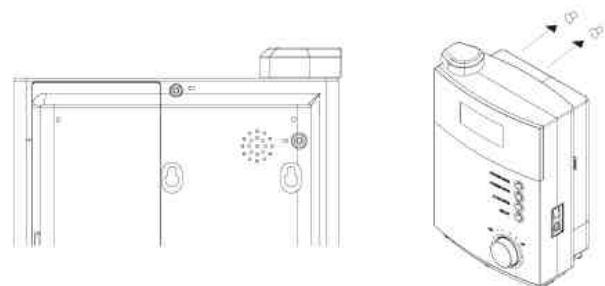



## INSTALLATION PROCEDURE

- ① Locate the unit on a proper flat surface.

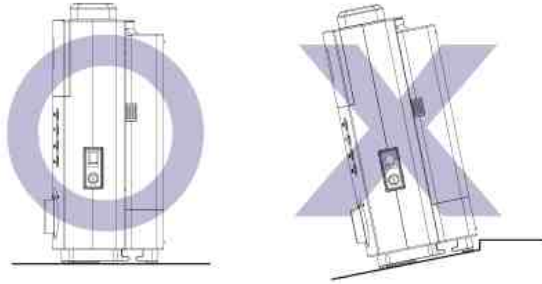

- ② Connect the provided 1/4" hose to Water Inlet Port firmly.

- ① In case of one touch fitting type, have Water Inlet Port nozzle put into the hose hole completely (fasten the safety key thereon after the connection).
- ② In case of two touch fitting type, give a nut good screw thereon for the knot not to be loosened.

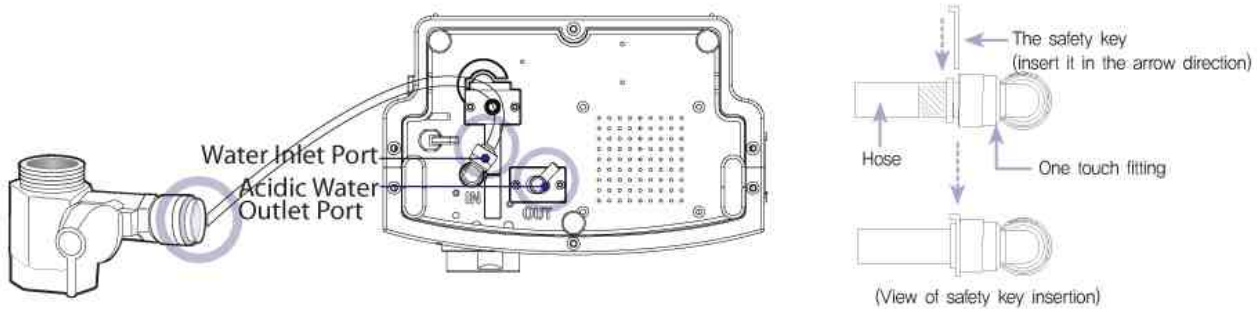

- ③ Connect the hose to Acidic Water Outlet Port and cut the other end of the hose in a sufficient length to reach the sink for draining away acidic water or for connecting to an acidic water bucket.  
(Option: Hose-fixation holder can be used for convenience sake)

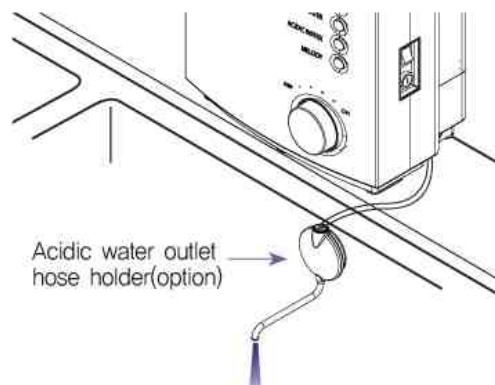

- ▶ In case the acid water outlet hose is steeped in water in a receptacle or the hose is unnecessarily long stretched out, an outflow rate of ionized water might be hanged. For the reason, maintain the properly shorter hose length so as not to be steeped in a receptacle.
- ▶ Do not lift the acidic water outlet hose up to the height of the installed unit. Otherwise it will hinder a water drain from the unit and will cause an unit disorder.

## USAGE OF THE ALKALINE WATER OUTLET DISPENSER

The Alkaline Water Outlet Dispenser on the top of an unit is of a fold-down type. Handle the dispenser as per the following systematic way.

- ① Lift up the dispenser to the height of an unit to have it positioned horizontally.

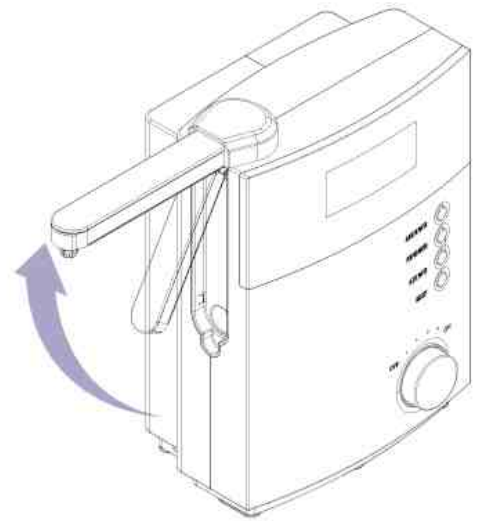

- ② Pull out the end of the dispenser to the left direction horizontally. The dispenser arm has the two stage stretch. (If needed, it may not be pulled out to receive alkaline water there from.)



- ③ Have the dispenser positioned in the intended direction, it can be horizontally rotated.

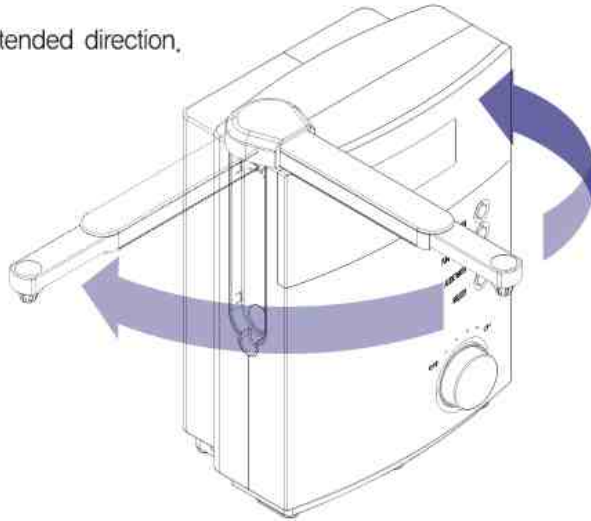

### USAGE OF THE ALKALINE WATER OUTLET DISPENSER COVER

Push and attach the cover onto the position as shown in the below picture.

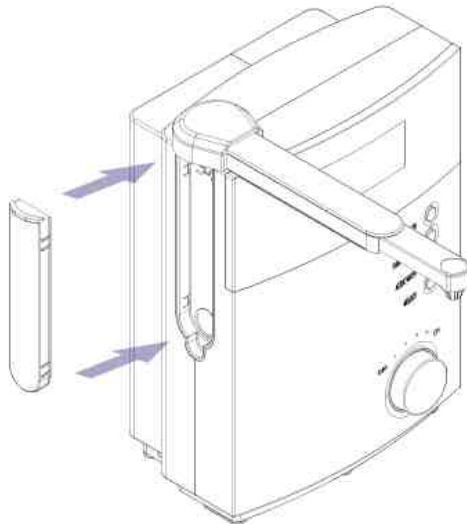

- ▶ At usual time of the unit use, have the underneath face of the alkaline water outlet dispenser be covered by the cover. It protects the dispenser surface and prevents any possible attachment of foreign materials there onto.
- ▶ In case of no use of an unit for a long time period, fold down the dispenser and relocate it back to the dispenser holder room for keeping the unit in safety. In case acidic water outlet hose is unnecessarily long stretched out, an outflow rate of ionized water might be changed. For the reason, maintain the properly shorter hose length so as not to be steeped in a receptacle.
- ▶ Do not lift the acidic water outlet hose up to the height of the installed unit. Otherwise it will hinder a water drain from the unit and will cause an unit disorder.

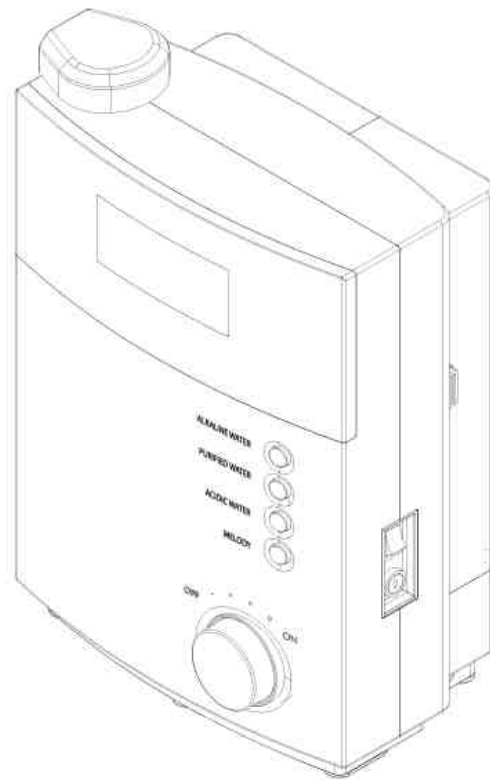

Unit Body

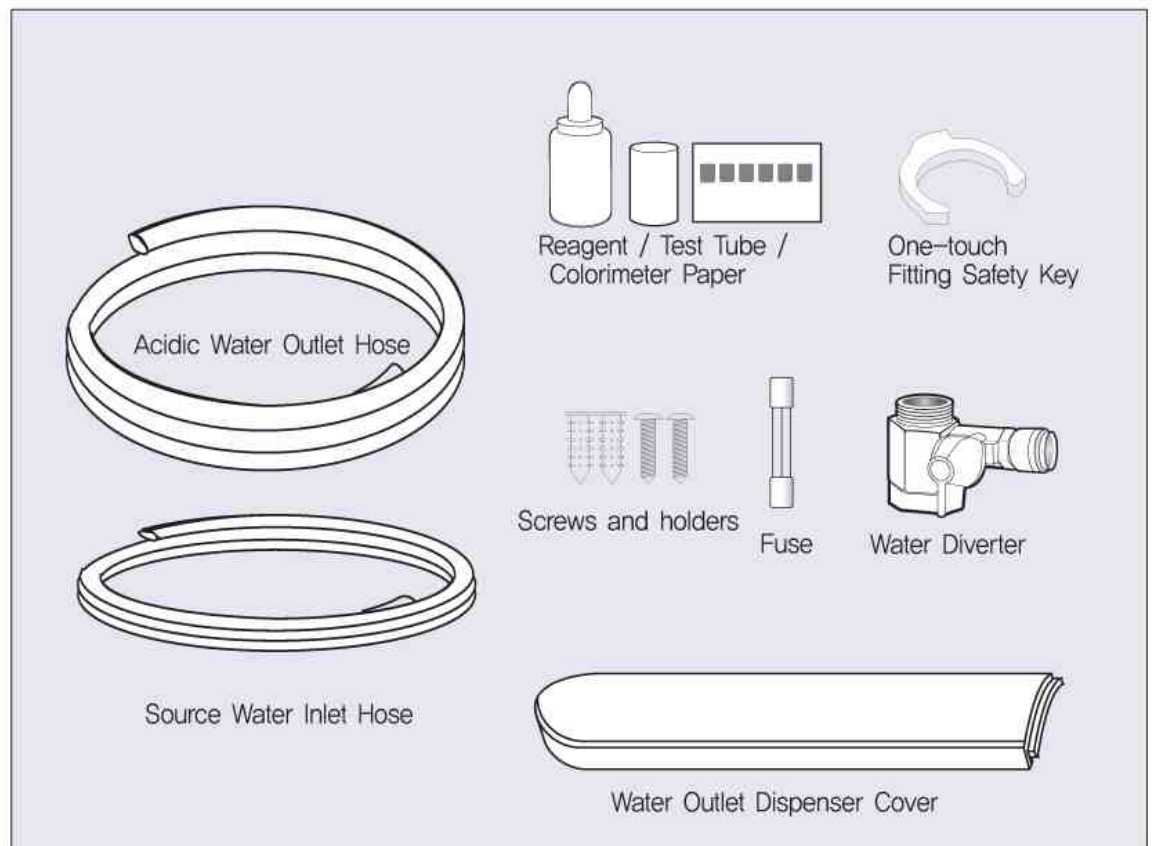



## HOW TO OPERATE-POWER / WATER SUPPLY

## 1 Plug in the AC Power Code.

- ▶ Completely plug in the power code for firm insertion.



## 2 Turn on the Main Power Switch on the right side.

- ▶ Then the unit will beep and the LCD Screen will display the initial modes

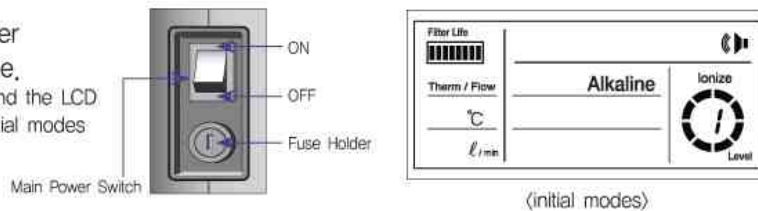

## 3 Slowly rotate the Water Supply Valve clockwise to have the water inflow into the unit.

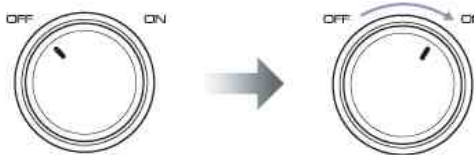

## 4 Have a check on water inflow rate as shown in the screen.

- ▶ The water inflow rate is indicated in a numerical value.
- ▶ The optimum inflow rate is 2.0~2.5 liters/min.
- ▶ In case it indicates a high or low inflow rate, check up the water inflow pressure and adjust the water inflow rate by the Water Supply Valve.
- ▶ The screen backlight color will be varied according to the chosen function and pH level.

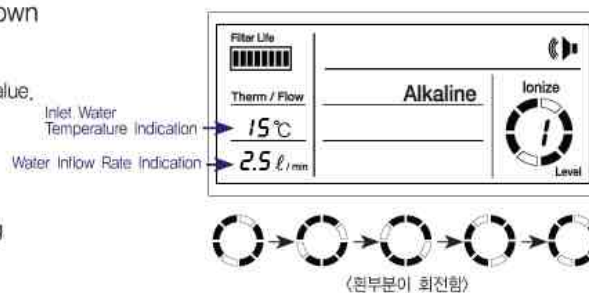

## 5 Operate the unit at the mode as you want.

- ▶ For your intended usage, choose alkaline ionizes water (p23), acidic ionized water (p23) and purified water(p23).

## HOW TO STOP THE OPERATION

## 1 Rotate the Water Supply Valve counterclockwise (OFF) to shut off the water inflow into the unit.

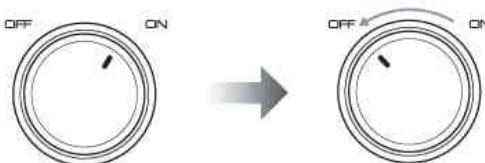

## 2 Then the unit will return to a standby (waiting) status after a water flow direction alteration valve works.

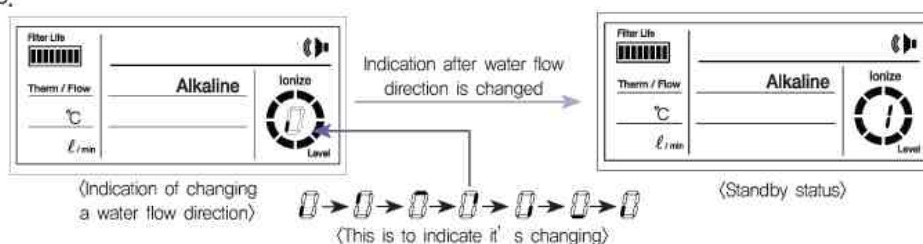

- ※ Occasionally there is a noise, "tick" from inside the unit after stopping the operation. This is not an disorder, but the normal noise when the drain valve is opened and closed.

HOW TO OUTPUT ALKALINE IONIZED WATER

- 1 Rotate the Water Supply Valve clockwise to have a water inflow into the unit,

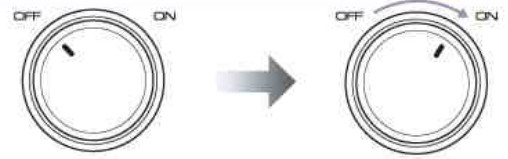

- 2 Push the Alkaline Water Button and choose the pH level by pushing the button repeatedly,

- ▶ Alkaline water comes out from the Alkaline Water Outlet Dispenser and acidic water comes out from the Acidic Water Outlet Hose,
- ▶ pH level number is alternated in regular sequence of 1→2→3→4→1→2→3→4 when you push the button repeatedly,
- ▶ The screen backlight color will be varied according to the chosen pH level,

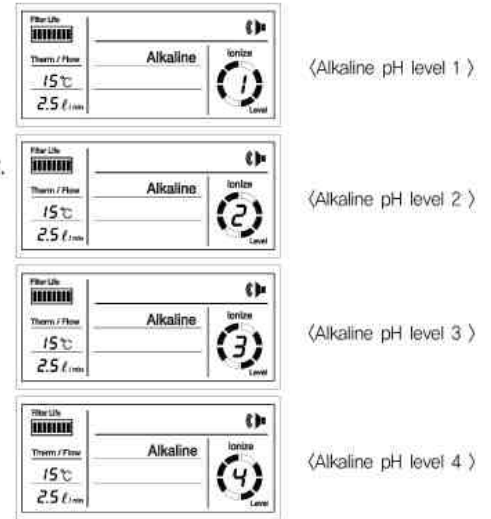
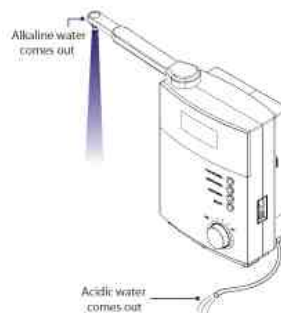

- 3 When you push the Alkaline Water Button during the purified water mode,

- ▶ The unit gives the "Alkaline pH level 1" voice notice,
- ▶ Alkaline water is generated after the water flow direction alteration valve works,
- ▶ Alkaline water comes out from the Alkaline Water Outlet Dispenser and acidic water comes out from the Acidic Water Outlet Hose,
- ▶ pH level number is alternated in regular sequence of 1→2→3→4→1→2→3→4 when you push the Alkaline Water Button repeatedly,

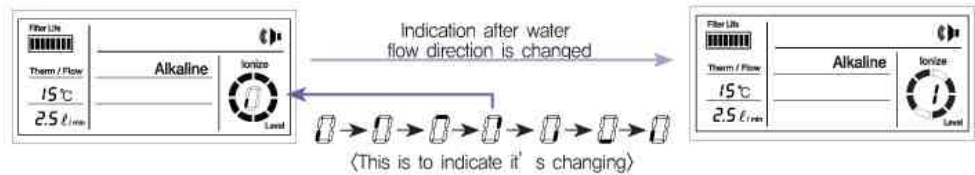

HOW TO STOP THE OPERATION

- 1 Rotate the Water Supply Valve counterclockwise (OFF)

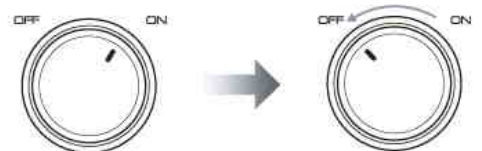

- 2 Then the unit will return to a standby (waiting) status after a water flow direction alteration valve works,

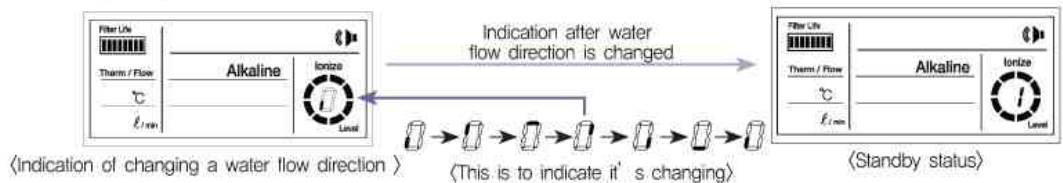

HOW TO OUTPUT ACIDIC IONIZED WATER

1 Rotate the Water Supply Valve clockwise to have a water inflow into the unit,

▶ Alkaline water mode appears initially



2 Push the Acidic Water Button for acidic water outlet mode,

- ▶ The unit gives the "Acidic pH level 1" voice notice (in case of pH level 1 mode) and melody.
- ▶ Alkaline water comes out from the Acidic Water Outlet Hose and acidic water comes out from the Alkaline Water Outlet Dispenser.
- ▶ pH level number is alternated in regular sequence of 1→2→1→2 when you push the button repeatedly.
- ▶ The screen backlight color will be varied according to the chosen pH level.

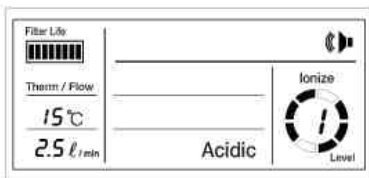
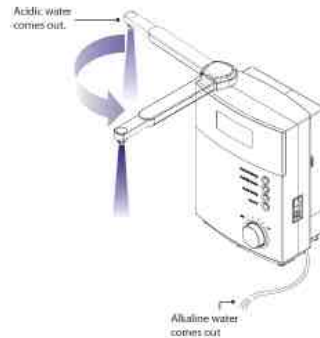

<Acidic pH level 1>

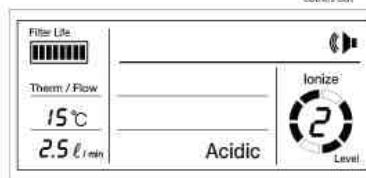

<Acidic pH level 2>

3 When you push the Acidic Water Button during the purified water mode,

- ▶ The unit gives the "Alkaline pH level 1" voice notice and melody, 1→2→1→2
- ▶ Acidic water is generated after the water flow direction alteration valve works (about 15 seconds).
- ▶ Alkaline water comes out from the Acidic Water Outlet Hose and acidic water comes out from the Alkaline Water Outlet Dispenser.
- ▶ pH level number is alternated in regular sequence of 1→2→1→2 when you push the Acidic Water Button repeatedly.

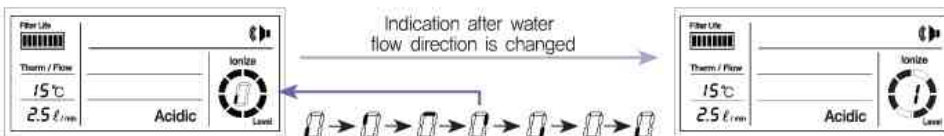

<Indication of changing a water flow direction > <This is to indicate it's changing>

HOW TO OUTPUT PURIFIED WATER

1 Rotate the Water Supply Valve counterclockwise (OFF)

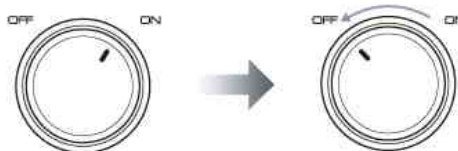

2 Then the unit will return to a standby (waiting) status after a water flow direction alteration valve works,

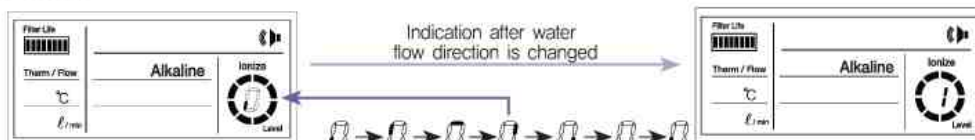

<Indication of changing a water flow direction > <This is to indicate it's changing> <Standby status>



HOW TO OUTPUT PURIFIED WATER

- 1 Rotate the Water Supply Valve clockwise to have a water inflow into the unit.

▶ Alkaline water mode appears initially.

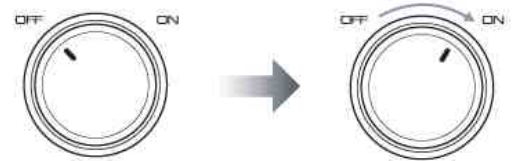

※NOTICE: The purified water mode can be chosen even during the alkaline or acidic water mode.

- 2 Push the Purified Water Button for purified water outlet mode.

- ▶ The unit gives the "purified water" voice notice.
- ▶ Purified water comes out from alkaline outlet dispenser after the flow direction valve works, (No water comes out from the Acidic Water Outlet Hose)
- ▶ The screen backlight color will be varied to indicate the purified water mode.

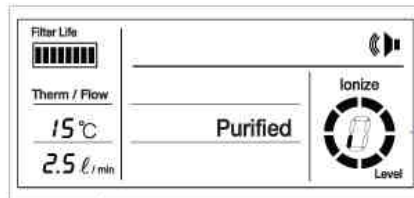
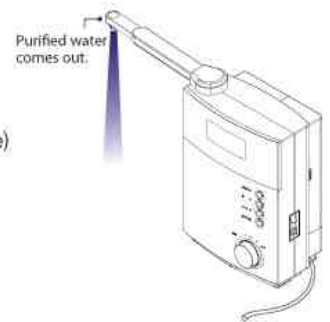

⟨Purified water choice indication: water flow direction alteration valve works⟩



⟨Indication of working of water flow direction change⟩

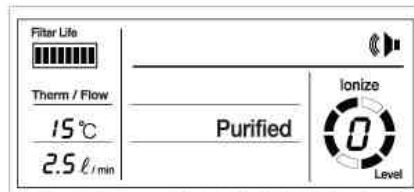

⟨Water-purifying operation status: water flow direction alteration valve stopped it's working⟩

HOW TO STOP THE OPERATION

- 1 Rotate the Water Supply Valve counterclockwise (OFF)



- 2 Then the unit will return to a standby (waiting) status after a water flow direction alteration valve works.

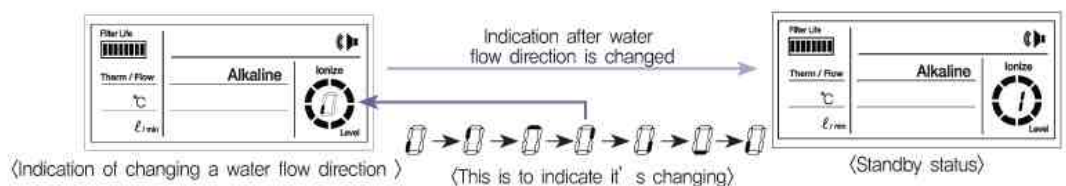



## MELODY ON/OFF

**1** Just push the Melody Button to turn on or offer the melody sound.

- ▶ Push the Melody Button, and the melody sound will be mute,
- ▶ Push the Melody Button once again, and the melody sound will be on with appearance of a melody icon on the LCD Screen,
- ▶ The melody function works only in the acidic water outlet mode.
- ▶ A voice guide works even in case the melody sound is off.

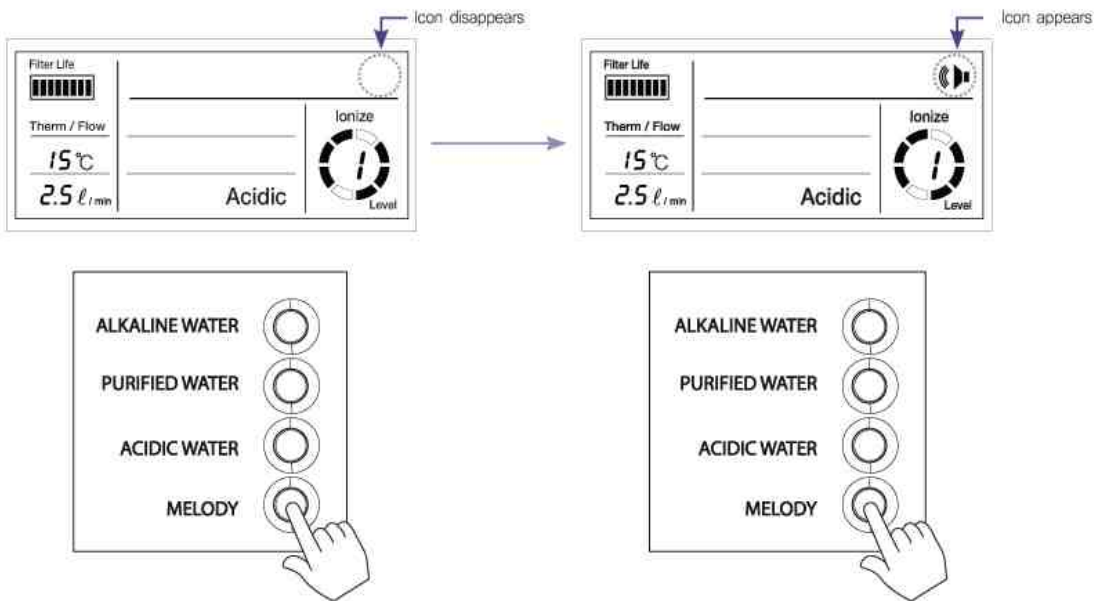

**2** Melody speaker volume adjustment

- ▶ Pushing the Melody Button and at the same time pushing the Alkaline Button once, twice, Trice – – so on can adjust the melody sound volume.  
(The melody volume adjustment can be made only when the melody icon appears)

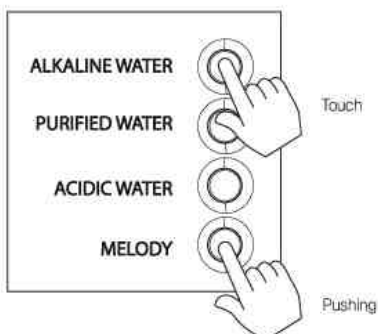

FILTER REPLACEMENT

- 1 Replace the filter when the Filter Life Indicator flickers.

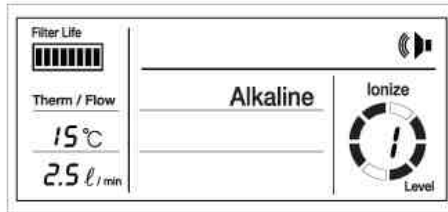

► When a filter life is over, the filter life icon flickers and there is a voice guide "please replace with a new filter".

It is the filter replacement timing when the icon flickers,

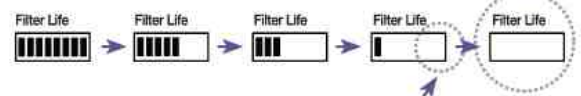

The icon starts flickering when 3 % of the full filter life remains available

- 2 Shut off the water inflow into the unit.

► Turn off the Water Supply Valve.

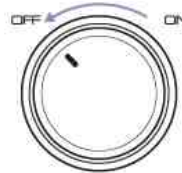

- 3 Open the Filter Cover as shown in the below pictures.

1. Push the filter cover lock part in the arrow direction.

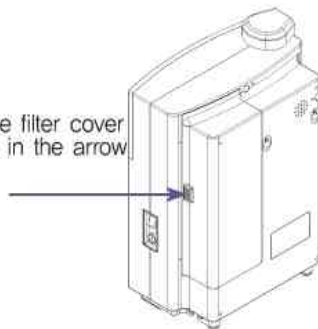

2. Pull the filter cover in the arrow direction and disassemble it from the unit body.

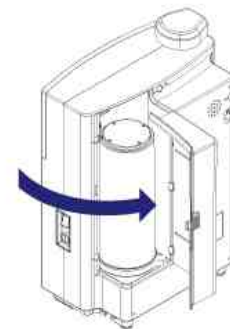

- 4 Disconnect the Filter Connection Terminal, drag the filter handle to the left direction and pick out the used filter cartridge.

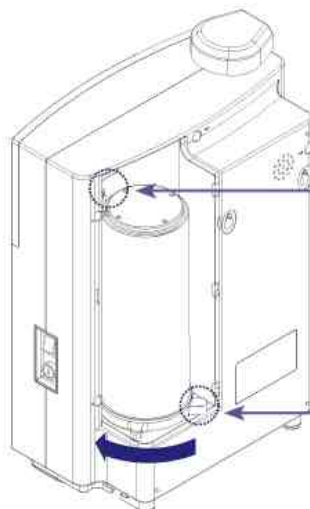

Drag the filter handle

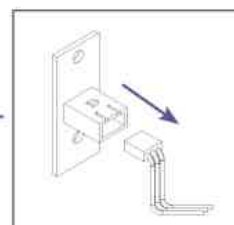

Disconnect the Filter Connection Terminal

Filter handle

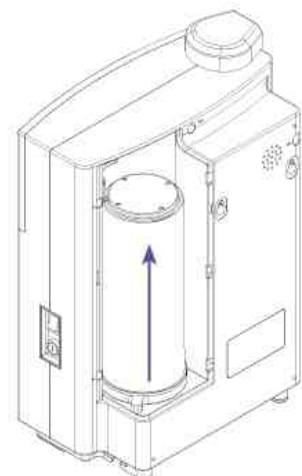

Pick out the used filter cartridge in the arrow direction.

- 5 Replace the used filter cartridge with the new one.

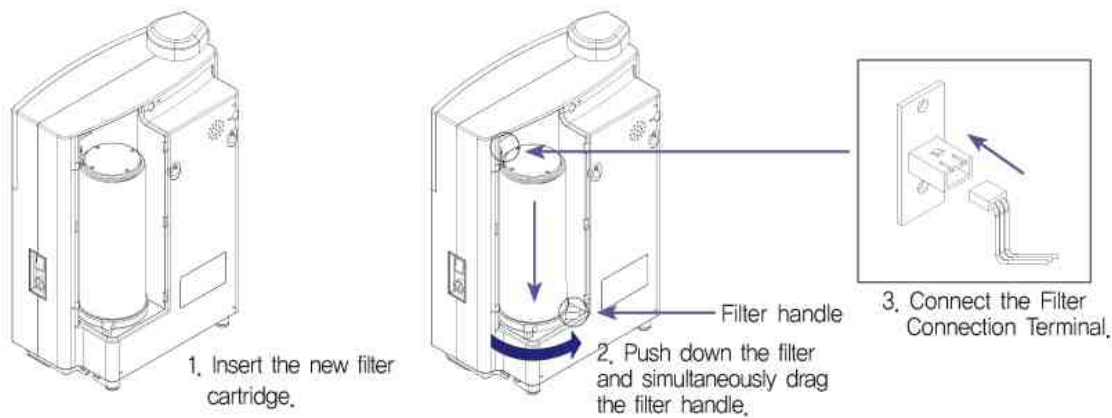

- 1 Insert the new filter.
- 2 Push down the filter and drag the filter handle at the same time.
- 3 Connect the filter top cable with the Filter Connection Terminal.

※ Water will leak from the filter connection points when the O-ring is damaged or taken off. Carefully have the O-rings positioned correctly when a filter replacement is made.

- 6 Turn off the Main Power Switch and have a water inflow into the unit for 2 ~ 3 minutes, turning on the Water Supply Valve (repeat it 2 or 3 times).

※ After replacing with a new filter, initial outlet water may be dark-colored. Such a dark-color is caused by an outflow of active carbon fines from the new filter. The carbon fines (fine size particles) are not harmful for drinking with and will not outflow no longer after having a 2 ~ 3 minute water inflow into the unit with no power supply.

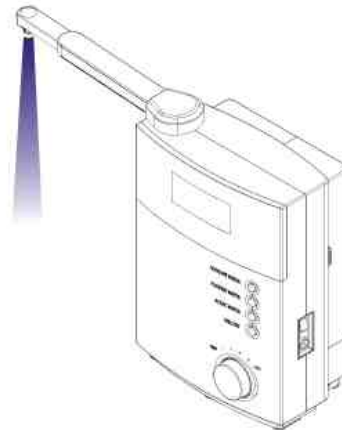

- 7 Check if any water leakage is found and make sure of no water leakage. Turn on the Main Power Switch. Push the Reset Button over 3 seconds to initialize counting a filter life. Close the filter compartment cover.  
→ The filter life reset button may not be available according to unit's function performance.

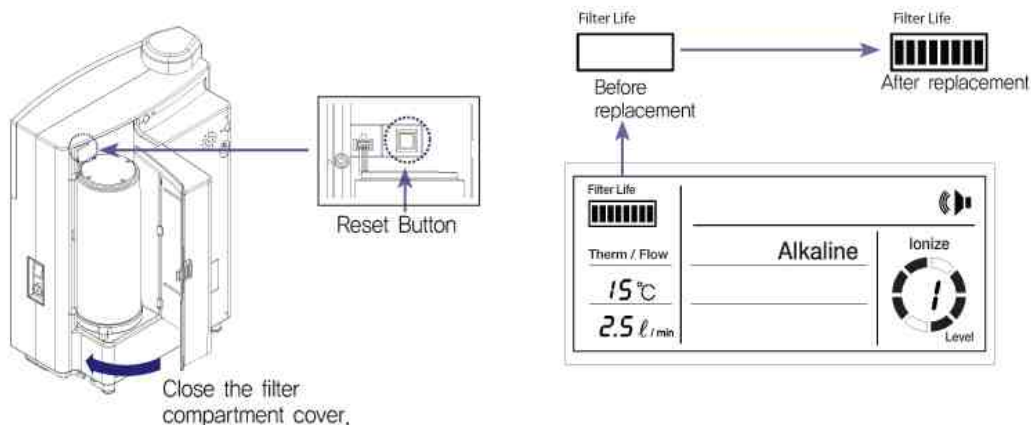

Please replace the presently using filter with the new one even if the Filter Life Indicator still does not give the replacement timing (  ), in the event of the following abnormal conditions,

- ▶ Much less water outflow from the unit or strange smell from outlet water since too high level of foreign substances has clogged the filter by extremely polluted source water used,
- ▶ When you re-use the unit after a substantial long time interval of no use of the unit,
- ▶ When water-circulating amount gets much reduced or outlet water taste is changed,
- ▶ In case of over 6 month period passed on after the previous use of the machine,

※ A filter life length can be changed according to a source water quality and unit operation condition.

**8** Producer's authentically approved filter must be used for the unit,  
The following conditions are caused when an authentically approved filter is not used,

- ▶ The unit has the function of self-check of the integrated system before an operation starts,
- ▶ The voice guide, "please insert an authentically approved filter" is given, in case an authentically approved filter is not used in the filter compartment,
- ▶ Alkaline ionized water is not generated even if output water comes out,
- ▶ It gives the warning by flickering the filter icon and disorder icon that the used filter is not an authentically approved one,
- ▶ In that case, please replace with an authentically approved filter and connect with the filter cable terminal,

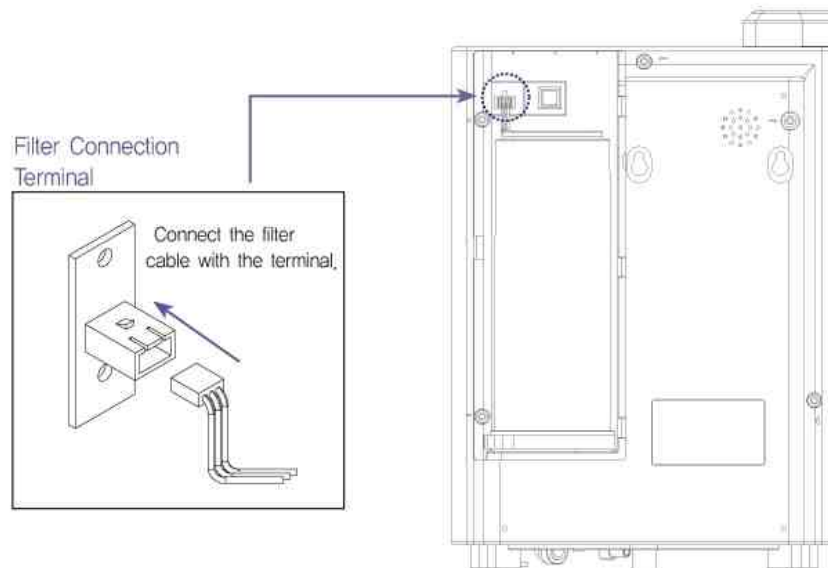
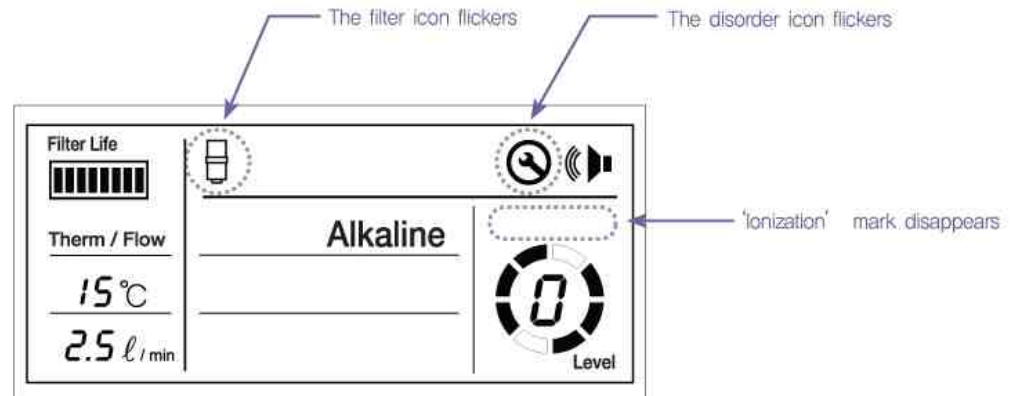



## CARBON FILTER COMPOSITION

- ▶ **Silver-impregnated (germicidal) active carbon layer**  
Silver is coated on the surface of the active carbon particles to retard bacteria's propagation. This layer eliminates bad tastes, odor, agrichemicals, disinfectants, phenol, trihalomethane and other harmful hemicals in source water.
- ▶ **Active carbon particle layer**  
This layer eliminates bad tastes, odor, agrichemicals, disinfectants, phenol, trihalomethane and other harmful hemicals in source water.
- ▶ **Calcium layer**  
This layer eliminates chlorine in water
- ▶ **PP filter**  
It filtrates the suspended substances, rust and sediments etc.



## ULTRA HOLLOW MEMBRANE FILTER COMPOSITION

- ▶ **Ultra hollow membrane filter**  
The micro size pores filtrate pollutants and/or impurities.
- ▶ **Silver-impregnated (germicidal) active carbon layer**  
Silver is coated on the surface of the active carbon particles to retard bacteria's propagation. This layer eliminates bad tastes, odor, agrichemicals, isinfectants, phenol, trihalomethane and other harmful chemicals in source water.
- ▶ **Active carbon particle layer**  
This layer eliminates bad tastes, odor, agrichemicals, isinfectants, phenol, trihalomethane and other harmful chemicals in source water.
- ▶ **Calcium layer**  
This layer eliminates chlorine in water.
- ▶ **PP filter**  
It filtrates the suspended substances, rust and sediments etc.

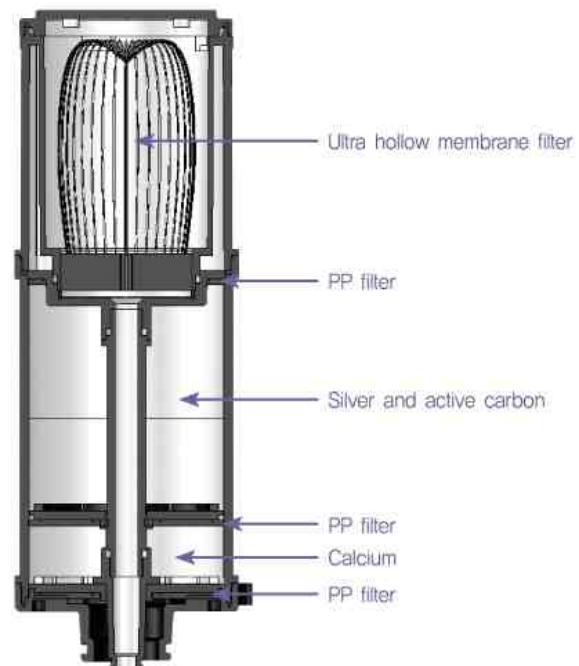

COMPERATIVE pH TEST

- 1 Fill up to 2/3 of each provided test tube or a container with alkaline ionized water, acidic ionized water and tap (city) water respectively,

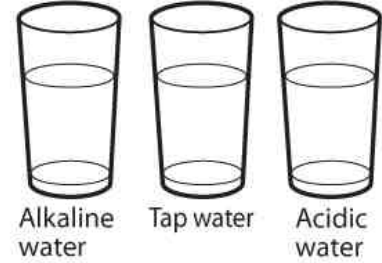

- 2 After putting two or three drops of pHtest reagent into each tube, shake the tube or container properly to mix up well,

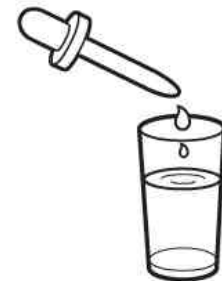

- 3 Determine each pH value by comparing the mixed solution color with the colorimetric analysis chart provided with,

- Level 4 ···· About pH 10 alkaline
- Level 3 ···· About pH 9,5 alkaline
- Level 2 ···· About pH 8,8 alkaline
- Level 1 ···· About pH 8,0 alkaline

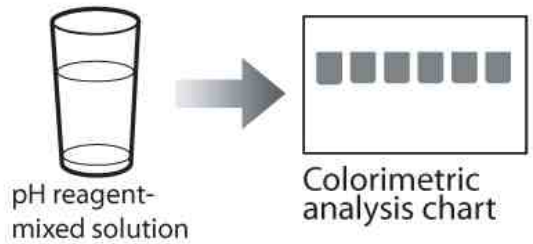

※Obtainable pH value can be varied according to source water quality, water inflow pressure and water temperature.



- ▶ Do not drink any water mixed with pH test liquid,
- ▶ Put the pH test liquid bottle and colorimetric analysis paper into a vinyl bag and keep the vinyl bag in a dark and cool place,
- ▶ Keep it away children and flammables,
- ▶ In case the pH test liquid is splashed into eyes or mouth by mistake, flush well with clean water.

## GENERAL USAGE OF IONIZED WATER

For a beginner, drink at low alkalinity pH and thereafter at gradually higher pH.



Alkaline water  
10.0

For cooking preparation,  
Good for removing bitter taste from vegetables.  
Use for washing vegetables and for boiling foods.  
Good for making food more lucid and vivid.



Alkaline water  
9.5

Most proper to make a barley tea and oolong tea.  
Can make teas softer in 1/2 less time than if  
conventional water is used



Alkaline water  
8.8

To cook rice.



Alkaline water  
8.0

Proper for a beginner with AKW  
(alkaline ionized water).



Alkaline water  
7.0

For taking a medicine and mixing with powdered  
baby milk.  
Also for usual drinking.



Alkaline water  
6.0~3.0

For skin care and face-washing.  
For cleaning after face-washing, bathing and shaving.  
For washing kitchenware and tableware.  
For use on some house plants and flowers



Abnormal condition	Cause	Treatment
Main power lamp does not come on.	<ul style="list-style-type: none"> <li>· Insufficient water inflow.</li> <li>· A power plug is not properly plugged in.</li> </ul>	<ul style="list-style-type: none"> <li>· Increase water inflow.</li> <li>· ensure that power cord is plugged in.</li> </ul>
	<ul style="list-style-type: none"> <li>· The fuse is blown.</li> <li>· The fuse is not inserted properly.</li> </ul>	<ul style="list-style-type: none"> <li>· Replace the fuse (250V T2AL).</li> </ul>
Ionized Water Lamp does not turn off even after turning the tap off.	<ul style="list-style-type: none"> <li>· Abnormality of PCB.</li> </ul>	<ul style="list-style-type: none"> <li>· Immediately pull a plug out of a socket and then contact the selling agent for service.</li> </ul>
On pH test with a reagent, acidic water color gets yellow, but alkaline water color indicates pH neutrality.	<ul style="list-style-type: none"> <li>· No alkalinity color appearance can be the result from a chemical reaction with carbonic acid in the water.</li> </ul> <p>※Alkalinity is in inverse proportion to acidity. Therefore, showing an acidic reaction means that inversely alkaline water is generated from the unit.</p>	<ul style="list-style-type: none"> <li>· Test pH value with Level 4 water (strong alkaline water).</li> <li>· Test pH value after having water inflow into the unit for the time being.</li> </ul>
Power supply is suddenly cut off during operation.	<ul style="list-style-type: none"> <li>· Too high TDS.</li> <li>· Too long time operation at high pH Level.</li> <li>· In case of well water used.</li> </ul>	<ul style="list-style-type: none"> <li>· It is not of disorder. It is apparatus' automatic function to protect the unit mechanism from a possible excessive electric current. The unit will automatically re-operate after cooling off.</li> </ul>
Reduced output of ionized water from the unit	<ul style="list-style-type: none"> <li>· Filter is clogged.</li> <li>· Filter clogging may be caused by sudden inflow of seriously polluted source water, even if a filter life is still effective.</li> </ul>	<ul style="list-style-type: none"> <li>· Filter replacement is needed.</li> </ul>
	<ul style="list-style-type: none"> <li>· Low inflow pressure.</li> </ul>	<ul style="list-style-type: none"> <li>· Take a hose away from the diverter adaptor and make sure that diverter valve is not clogged.</li> <li>· Check water inflow pressure.</li> </ul>
	<ul style="list-style-type: none"> <li>· The supply hose is kinked.</li> </ul>	<ul style="list-style-type: none"> <li>· Straighten the kinked hose.</li> </ul>
Output water comes out, but alkaline water has the neutral pH (no ionization). The voice guide, "please check the filter connection" is given.	<ul style="list-style-type: none"> <li>· An authentically approved filter is not used.</li> <li>· An authentically approved filter is used, but the filter cable is not connected to the terminal</li> </ul>	<ul style="list-style-type: none"> <li>· Replace with the authentically approved filter.</li> <li>· Connect the filter cable to the filter cable terminal.</li> </ul>

※ What is TDS (Total Dissolved Solids) ?.

It means a total quantity of solids dissolved in water, i.e. calcium, magnesium, iron and other mineral solids.



Abnormal condition	Cause	Treatment
<p>Strange smell from output water</p>	<ul style="list-style-type: none"> <li>· Filter life (longevity) is expired,</li> <li>· Filter life is extremely shortened as bad quality water is used.</li> </ul>	<ul style="list-style-type: none"> <li>· Filter replacement is needed,</li> </ul>
<p>Milk-white materials precipitate on the bottom of an ionized water receptacle (alkaline and acidic water)</p>	<ul style="list-style-type: none"> <li>· Due to sudden change of source water quality and too much chlorine contained in the source water in summer season,</li> <li>· Infinitesimal chlorine might be present in output water,</li> </ul>	<ul style="list-style-type: none"> <li>· Select pH level 1~2, i.e. lower pH strength,</li> <li>· If still serious, filter replacement is needed,</li> </ul>
<p>At first no smell, but smell from the output water in about 1 hour after collecting ionized water.</p>	<ul style="list-style-type: none"> <li>· A water-keeping bottle or receptacle is contaminated,</li> <li>· Contamination is added into the bottle when collecting output water from the unit,</li> <li>· Filter is seriously polluted,</li> </ul>	<ul style="list-style-type: none"> <li>· Check cleanliness of a water-keeping bottle,</li> <li>· If odor persist after cleaning receptacle, replace a filter and select pH level 1~2, i.e. lower pH strength,</li> </ul>
<p>Water leakage from filter compartment</p>	<ul style="list-style-type: none"> <li>· The filter is not fitted firm on the filter base,</li> <li>· Rubber O-ring is taken off,</li> </ul>	<ul style="list-style-type: none"> <li>· Take out the filter, check the filter compartment and reinstall the filter,</li> <li>· Check the O-ring fitting condition,</li> </ul>
<p>No output of generated water from the acidic output hose,</p>	<ul style="list-style-type: none"> <li>· The output hose is kinked,</li> <li>· Insufficient water inflow into the unit,</li> </ul>	<ul style="list-style-type: none"> <li>· Straighten the kinked hose or check the hose condition,</li> <li>· Increase the quantity of source water inflow.,</li> </ul>

UNIT SPECIFICATIONS

Product Manufacture Permission No.	No. by KFDA	
Product Classification	Medical substance generator (Ionized water generator)	
Model	AMS2000	
Input Voltage	AC 250V 50Hz (Different voltage and Hz to be available as per user's requirement).	
Input Electricity (Power Consumption)	90W(0.4A)	
Weight	Approx 5,1kg	
Overall Dimension(H×w×D)	345×240×150(mm)	
Applicable Water Inflow Pressure Range	0.7~5Bar(Kgf/cm <sup>2</sup> )	
Applicable Water Temperature Range	5 ~ 30°C	
Unit Operation Type	One Touch Automatic Ionization Start	
Unit Operation Means	Tap-water-open and-close	
Elec- trolysis Device	Electrolysis Method	Continuous electrolysis
	Electrolysis Strength	1 ~ 4level
	Ionized Water Output Rate	Max 3 Liters / minute (alkaline + acidic water)
	Cleaning Device	Automatic system (no waiting interval)
	Electrode Materials	Platinum and Titanium
Water- purifying Device	Filter Replacement	Easily replaceable cartridge
	Filter Life (Duration)	Approx 6 months based on 20 Liters / day. Approx 3,600 Liters.
	Filter Life Indicator	Icon indication
	Filters	Pre-filters, silver-impregnated activated carbon filter and hollow membrane filter (option).
Hot Water Shutoff Device (for excessive current)	Temperature sensor / auto shutoff	
Water Supply	Direct connection to a faucet or water line	

## WARRANTY CARD

Product Name		Model No	AMS 2000
Serial No		Purchase date	
Seller	Shop name 		
	Address		
Buyer	Name 		
	Address		

This product passed the precise inspection under strict quality control. In case the product is found to have any defect in production or to get any spontaneous mechanical malfunction within the warranty term, return the unit to our sales agency, distributor or our service center along with this warranty sheet for repair free of charge.

### Warranty Regulations

1. Warranty term: 24 months from a purchasing date.
2. Exceptions to warranty:
  - ① Expiration of warranty terms.
  - ② Defect caused by a natural disaster such as fire, salt invasion, gas accident, abnormal voltage flow, earthquake or thunder etc.
  - ③ Disorder or damage caused by careless carry or transportation, careless dropping or installation failure etc.
  - ④ Damage or malfunction resulting from user' misuse or carelessness
  - ⑤ Damage or malfunction resulting from user' s own disassembling or repair.

Fill in this warranty card upon receipt of new unit.  
Receipt can be in force as warranty card.

# ALKAMEDI

DIGITAL WATER IONIZER

---

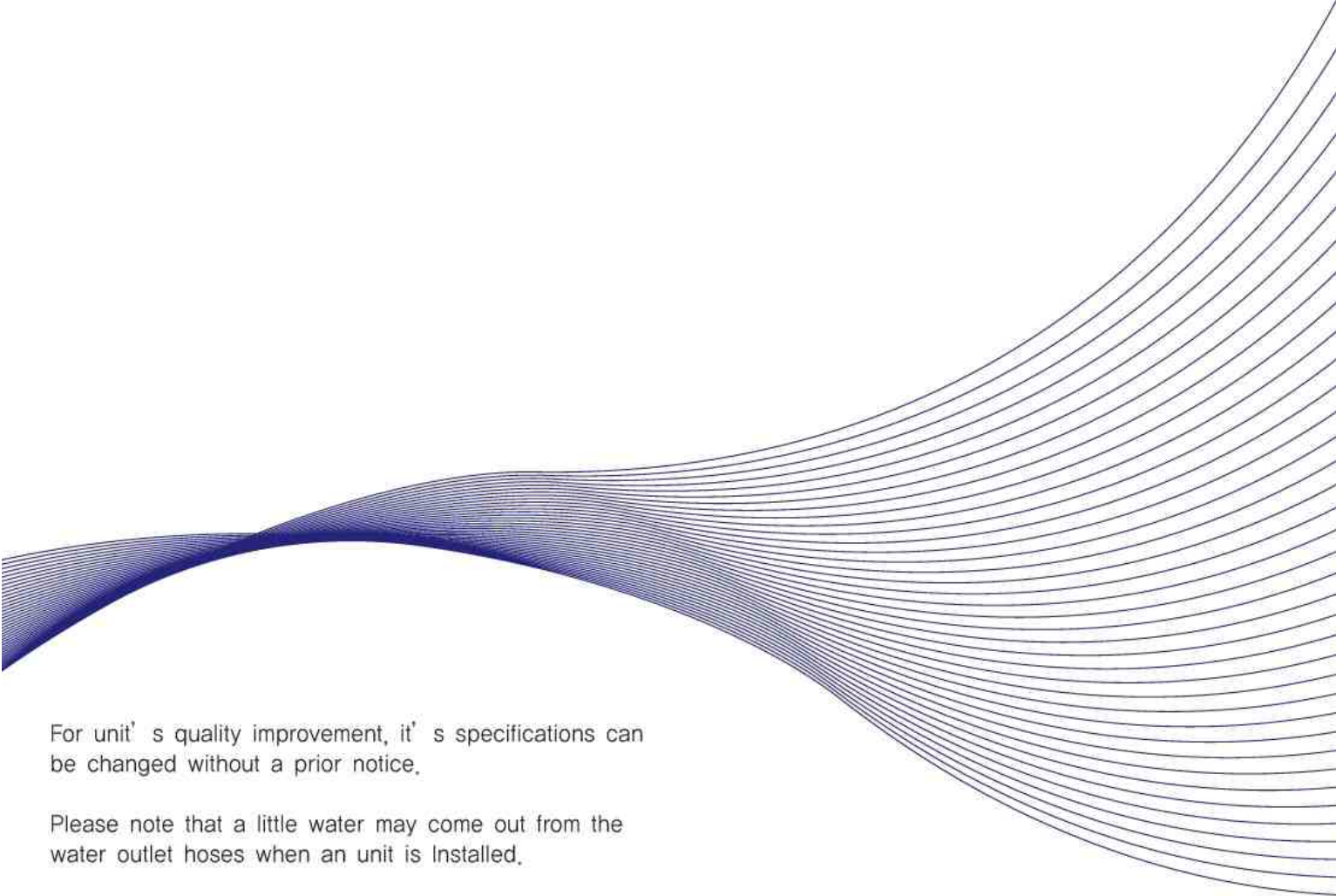

For unit' s quality improvement, it' s specifications can be changed without a prior notice.

Please note that a little water may come out from the water outlet hoses when an unit is Installed.

Such water used for quality test at the factory may remain inside of the unit.

Producer : ALKAMEDI Co., Ltd.  
Address : Mega-valley #701-2, 799, Gwanyang-dong,  
Dongan-gu, Anyang City, Gyeonggi-do, South Korea. (431-767)

---