

USER MANUAL



ALLS BON

Exclusive use of water-supply

- * The product is "medical equipment." Before use, please read the direction for the use of equipment carefully.
- * Use it properly, after read the instruction first. Keep the instruction well and read it when you need.
- * Keep the warranty card after fill in the warranty card.
- * As this product is for medical use, we do not have responsibilities for any defect or accident caused by faulty installation or wrong way of use.

Contents

Safety.....	04
Parts.....	08
Alkaline water usage guide.....	09
Acidic water usage guide.....	10
Definition of ion water.....	11
Operation Warnings.....	12
Operation Method.....	14
Indicator function and voice function.....	15
Installation guide.....	16
Installation method.....	17
Extraction method.....	19
Method for drinking alkali water and cautions.....	20
Internal Filter Replacement.....	21
Filter.....	22
Common Problems Solutions.....	23
Product specs.....	25

- Comply with this manual to install product properly.
As for the piping work, install by complying with all types of construction laws, water related laws and each city's regulations. Moreover, be careful since piping contact method may be different according to the type of the combination of the sink and sink cabinet.
- Check leakage, operation and amount of water for flowing down during final check-up.
- After installation is complete, user manual and warranty must be delivered to the customer.
- Designated pH may not come out depending on the region's water quality.
In particular, measure acid level prior to installing in the region where ground water is used as the water supplied.
- Our company won't be responsible for the malfunction or accident that results from non-compliance of the installation rules. Thus, check in advance impeccably.



Safety

Before carrying out any operation, it's important to read this instruction manual thoroughly so that your alkaline water ionizer is functioning at full capacity.





Some parts may be changed to increase product quality, function or for other reasons. In such a case, the manual may inconsistent with the actual contents.

Pictures

We provide you with pictures to prevent any improper use of the machine and to prevent property damage.

 Warning	It may cause major damage to your body
 Caution	Mishandling may cause either financial damage or even physical damage
 Danger	Mishandling may cause mortality or serious injury

Indications

	To provide caution, warning and danger signs
	To provide information on general prohibitions
	To instruct users on general operation
	To ban opening the machine when it is likely to cause a source of injury such as electric shock
	To instruct users to disconnect power plug in case of a malfunction



Warning Please read this thoroughly for your safety.

	<p>Mind the following when you drink alkaline water</p> <ol style="list-style-type: none"> 1. Do not take drugs or medications with alkaline water. They should be taken with purified water. 2. If you are suffering from achlorhydria (no stomach acid), do not drink the alkaline water.
	<p>Do not use undrinkable water (ground water, dirty water) or you may hurt yourself.</p>





Danger Please read this thoroughly for your safety.

	<p>The machine shouldn't be disassembled or repaired by an unauthorized person or it may cause an electrical fire. The manufacturer is not responsible for this.</p>
	<p>The machine shouldn't be placed in a humid area such as a bathroom. Do not clean by spraying the ionizer with water, as this can cause an electric shock.</p>
	<p>Power plug should not be touched or operated with wet hands and should be unplugged before any operation.</p>
	<p>Please follow these instructions when the machine, by error, has fallen into water or it may cause a source of electric shock.</p> <ol style="list-style-type: none"> 1. Unplug power plug from an outlet 2. Take the machine out of water and dry it in the shade 3. Consult with the retailer or manufacturer
	<p>Use only required voltage</p>
	<p>Make sure the power cord has not been crimped since it might cause a source of electric leakage. Water distribution hose should not be placed higher than the main machine or it may cause a malfunction.</p>
	<p>Power code shouldn't be adjusted with tools such as staple since damaged power code may cause a source of fire or electric shock.</p> <p>Do not connect multiple electric appliances with a single power receptacle.</p>





Warning Please read this thoroughly for your safety.

	<p>When an outlet has been covered with dust, it must be cleaned before putting the power plug in or it can cause electrical problems.</p>
	<p>Do not do damages power code by, bending, pulling, twisting or putting heavy objects on top of as this may cause an electrical fire.</p> <p>When power code and power plug has been damaged or an outlet comes loose, do not use.</p>



Danger Please read this thoroughly for your safety.

	<p>The machine should be placed horizontally in area in which there is no danger of dropping or hitting it.</p>
	<p>The machine should be installed away from direct sunlight or heaters such as a fire place or electric heater.</p> <p>Don't use hot water (over 104 degrees Fahrenheit), as it may cause damage.</p> <p>Don't put objects on top of the machine, as it may cause damage.</p>
	<p>Make sure the machine is correctly attached to the wall if you choose this method of mounting the machine.</p>



Warning

Please read this thoroughly for your safety.

	<p>If the machine has not been used for several days, run water through the machine for 1–3 minutes before starting the machine.</p>
	<p>Users who are not familiar with this water are recommended to start with alkaline water level 2 and adjust quantity/level of water to suit your needs. Generally alkaline water at level 2–3 is recommended but it depends upon your health conditions.</p>
	<p>Store alkaline water in an air tight container and put it in a refrigerator for up to 2 days.</p>
	<p>Do NOT drink: 1. Acid Water</p>
	<p>Don't fill the fish bowl with this water, as it can damage the fish.</p>
	<p>Don't use containers such as aluminum or brass, as they can be tarnished by this water.</p>
	<p>Contact the retailer if generated water smells bad, as you may need extra filtration or your source water may be contaminated. Please observe the following cautions when handling the reagent drops.</p> <ol style="list-style-type: none">1. Do not put it into eyes. If this happens, wash your eyes out and consult with doctor. Do not drink and if you do, then drink lots of water to flush out your system2. Store it in an airtight container away from children.3. Keep away from fire, as it is flammable.
	<p>Don't use water spray to clean the machine.</p>
	<p>Don't block the vent or insert items in the vent, as it can cause an electrical short.</p>
	<p>Don't block the water passage, as it can cause water leakage or malfunction.</p>

Definition of ion water

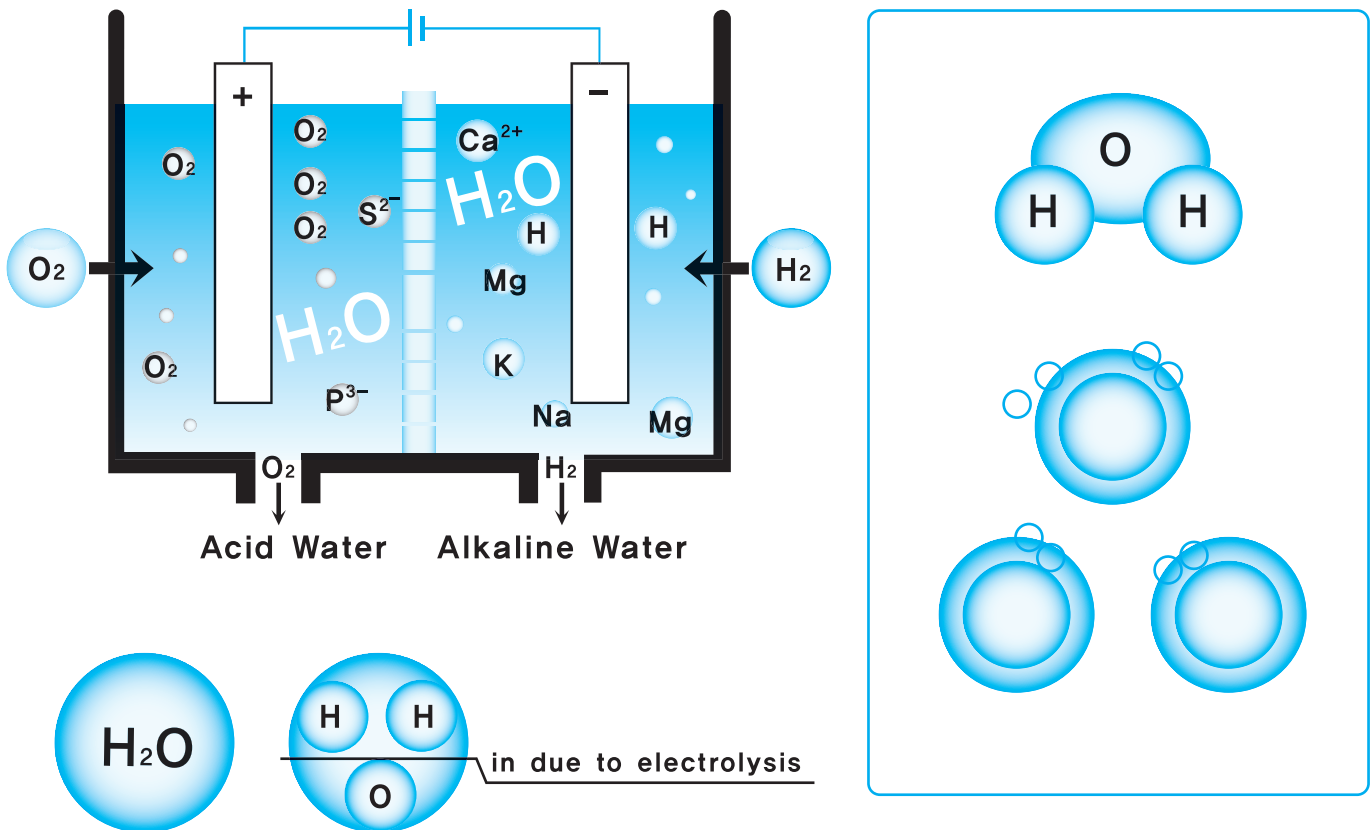

With electrolyzed water, the cathode (-) produces alkaline ionized water with minerals (pH scope 7.5~10) – such as Ca, K, Mg, Na, etc. because of the hydroxyl ion (OH-) generating reaction.

The anode (+) has lots of hydrogen (H+) (pH scope 3.5~6.5) because the oxygen gas (O₂) generates a reaction and acid ion water has many ions such as Cl, S, P. The alkaline ion water and acid ion water made by an electrolytic reduction water generator, has characteristics like those below.

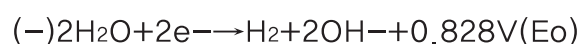
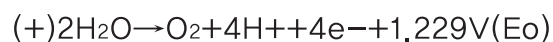

The level of acidity (PH) is marked from 1 to 14. Alkaline has a PH of more than seven and acid has a PH of less than seven.

$$\text{pH} = -\log[\text{H}^+]$$

Operation Warnings

Operation Warnings

- DO NOT use the ionizer with the following water as it can cause a breakdown of the machine!
 1. Dirty water
 2. Salt – water
 3. Water with high amounts of iron or rust
 4. Water Above 40°C



Read the instruction thoroughly before any operation

Parts for the Ionizer (front)

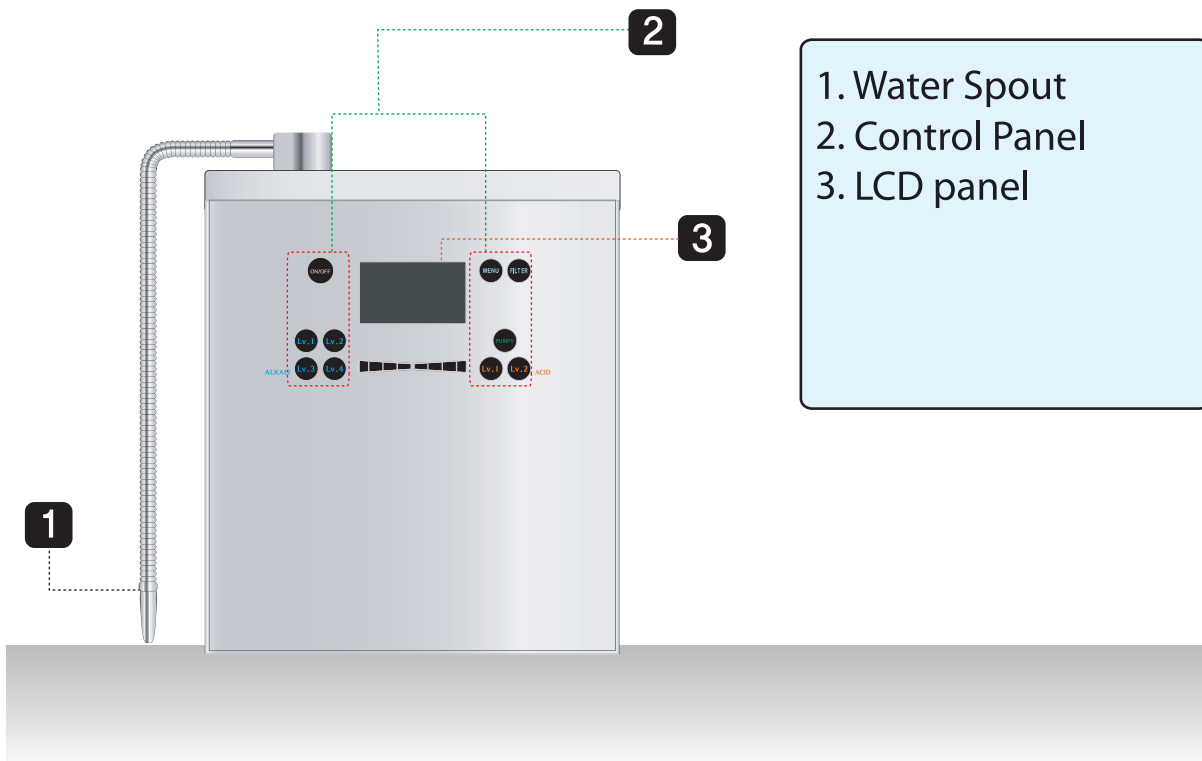

Parts for the Ionizer

Parts for the Ionizer(back)

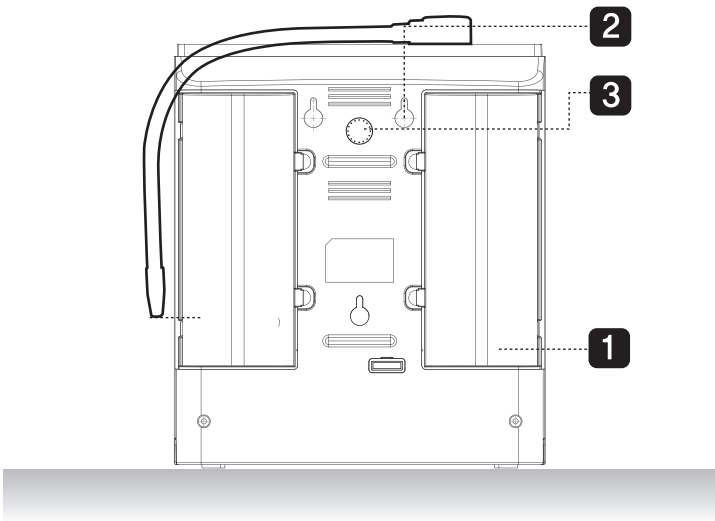

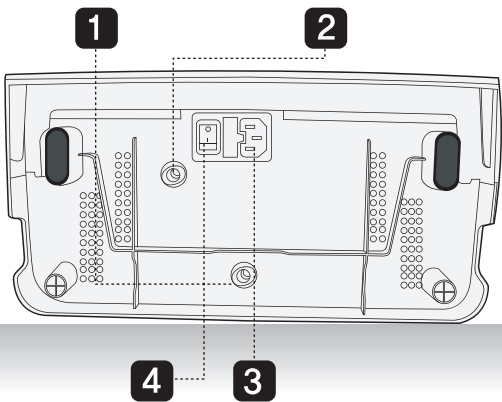

- 1. Filter Cover
- 2. Wall Mount Screw Holes
- 3. Speaker

Parts for the Ionizer(back)

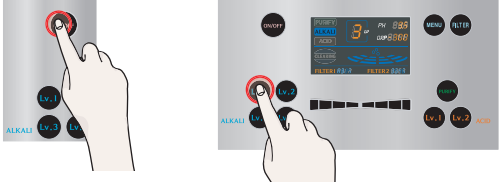

- 1. Outlet valve
- 2. Inlet valve
- 3. Power Plug
- 4. On/Off Power Switch

Operation Method

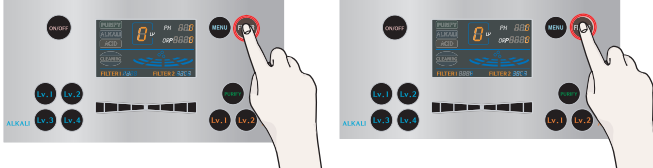
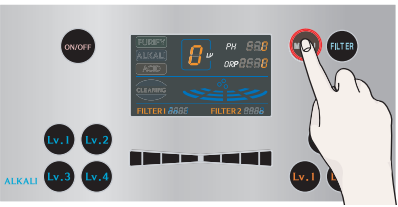
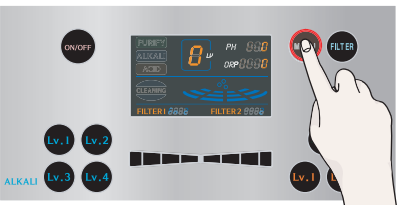
Operation Method	Description
	<p>When "Alkaline" water is chosen, Levels 1 to 4 can be selected by pressing the "Alkaline" button again.</p>
	<p>When "CLEAN WATER" is selected, pH is not indicated and level is "0"</p>
	<p>When "ACID WATER" is selected, Level 1 or 2 can be selected by pressing the "ACID WATER" button again.</p>
	<p>When replacing the filter while on the main menu, press the "1ST FILTER" or "2ND FILTER" button and hold for 5 sec. This resets the filter counter to 0000. The filter count goes to 9999.</p>
	<p>FN1 is the volume menu. Levels 0 to 4 can be selected by pressing the "2ND FILTER" (up) and "1ST FILTER" (down) buttons to increase or decrease the volume.</p>
	<p>When FN2 is selected with the "FUNCTION" button, the amperage setting can be adjusted from 0 to 4 by pressing the "2ND FILTER" (increase) and "1ST FILTER" (decrease) buttons.</p>



Caution

- Acidic water is not for drinking. Do not drink it.
- Let the water flow down for about five seconds after generation is started before using the water.
- Let the water flow down for about 10 to 15 seconds every day when starting to use water by opening up the faucet completely before using the water.
- Let the water flow down for at least 30 seconds before using when the water was not used for many days.

Indicator function and voice function

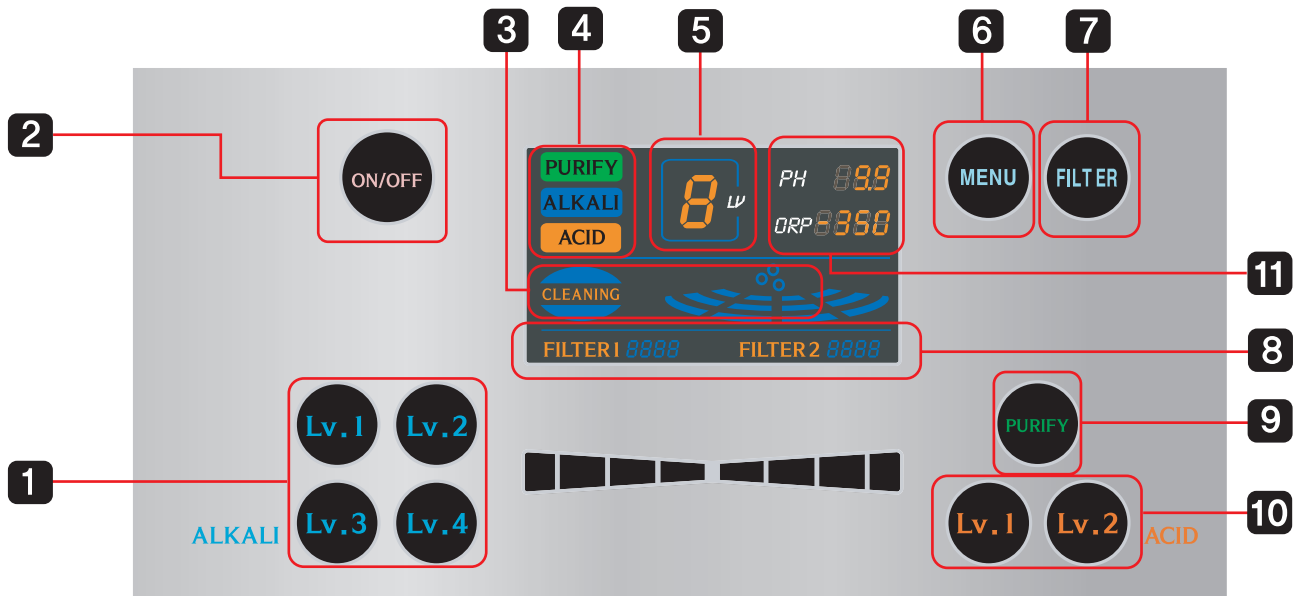

- | | |
|--|-----------------------------|
| 1. Alkaline water buttons | 2. Production water button |
| 3. Rotates while cleaning | 4. Indicates ion water type |
| 5. Indicates selected ionization water setting | 6. Menu button |
| 7. Filter button | 8. Filter life indicator |
| 10. Acid water button | 9. Clean water button |
| 11. pH indicator | |

Voice Functions

Voice: Please wait a few seconds as the machine is cleaning itself.

Water Cleaning

*Please wait a few seconds... as the machine is cleaning itself.

Ionized Alkaline Water

*4th grade of Ionized Alkaline Water is being extracted now.

*3rd grade of Ionized Alkaline Water is being extracted now.

*2nd grade of Ionized Alkaline Water is being extracted now.

*1st grade of Ionized Alkaline Water is being extracted now.

Acid Water Button

*2nd grade of acid water is being extracted now.

*1st grade of acid water is being extracted now.

Purified Water Button

*1st grade of clean water is being extracted now.



Please read this thoroughly for your safety.

Caution during installation

This product is exclusively for AC220V. Thus, must check voltage before plugging in the power code.

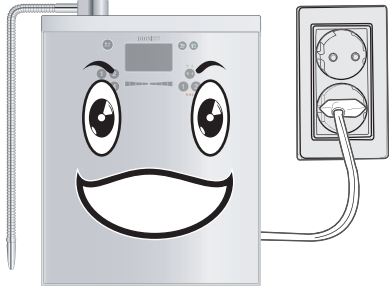

■ Inquire with the sales outlet or the HQs if you wish to use AC 110V.

Do not place at a location where there is direct light or where temperature falls below 0 Celsius.

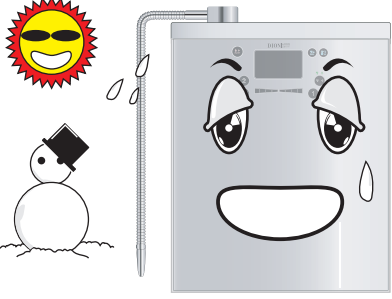

■ Case may get deformed or it may freeze.

Caution when connecting to the Acidic water hose

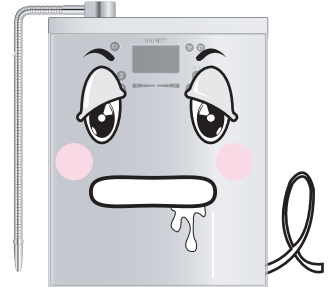

■ Acidic water hose should be installed lower than the main body.
■ When the hose is long or if it is higher than the main body, this may affect ion generation, which can change the taste of the water.

Must connect to the cold water piping. (When connected to warm water, filter for clean water and Electrolytic cell may be damaged.)

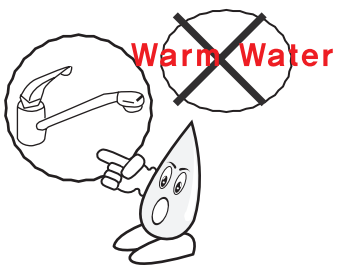

■ Filter's lifetime is decreased.

Avoid places where the product can come into contact with heat directly.

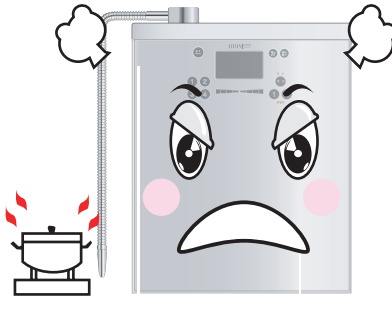

■ Case may be transmuted, causing leakage.

Do not change the device arbitrarily.

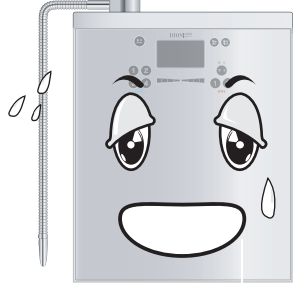

■ This may cause machinery malfunction or cause safety problem.

Do not move by holding onto the filter cover.

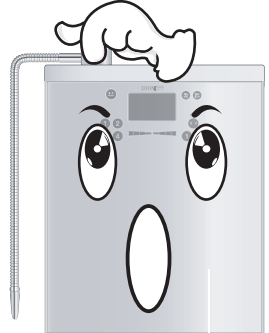

■ There is a possibility of getting damaged or injury may result when it separates from the main body.

Must hold onto the main body's plate at the bottom to move to ensure safety.



■ This may cause machinery malfunction or cause safety problem.

Do not use at humid or dusty place.

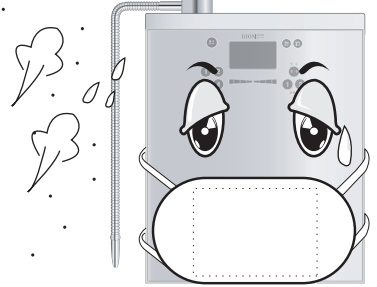

■ This may cause machinery malfunction or cause safety problem.

- When the product is dropped, this may cause internal malfunction or electrocution due to shock. Thus, inquire at the sales outlet or the HQs for inspection.
- When using at cold place during winter, keep it by taking out the filter for clean water since it may freeze when it is not used since the latter may be frozen.

Installation guide

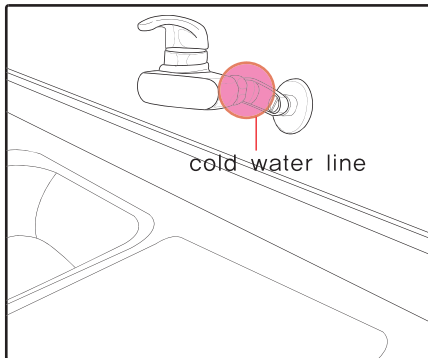

1. Turn off the main valve which comes into the house.

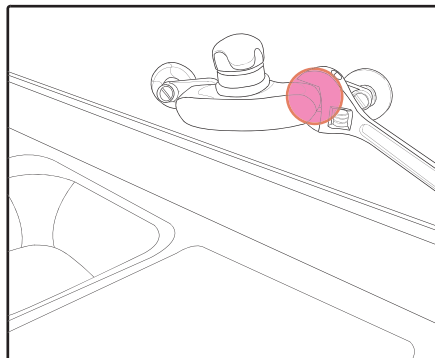

2. Disconnect the water tap from the water pipe.

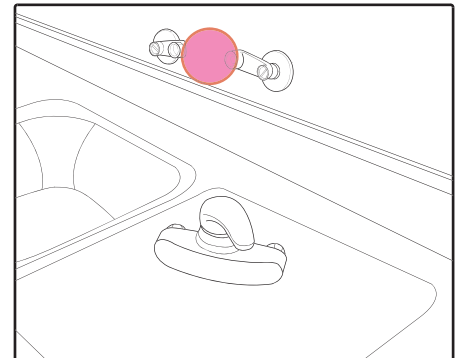

3. Clean the water pipe thoroughly to prevent breakdown of the machine.

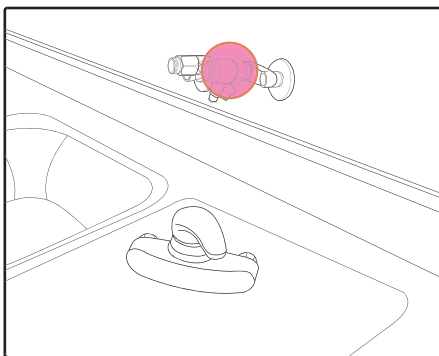

4. Connect the adapter to the separated water pipe

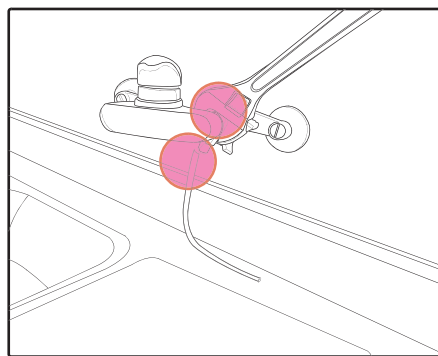

5. Fasten the adapter to prevent water leakage. Find the hose wire around the valve of adapter and connect.

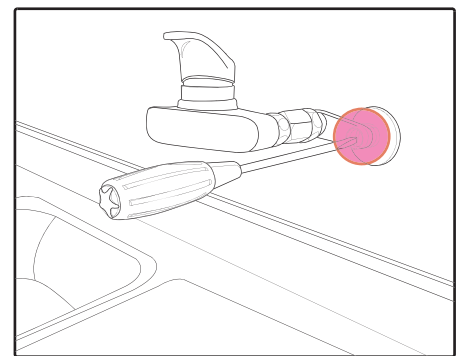

6. Turn on the main valve.

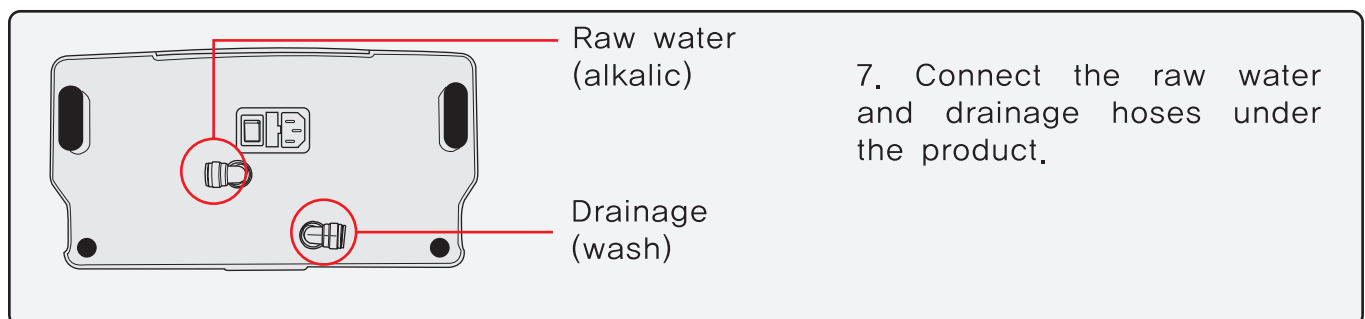

7. Connect the raw water and drainage hoses under the product.

Installation (Under sink)

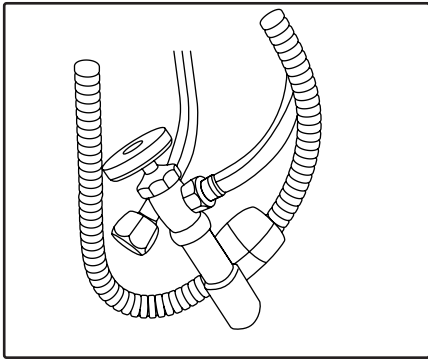

1. Find the raw water valve placed under sink.

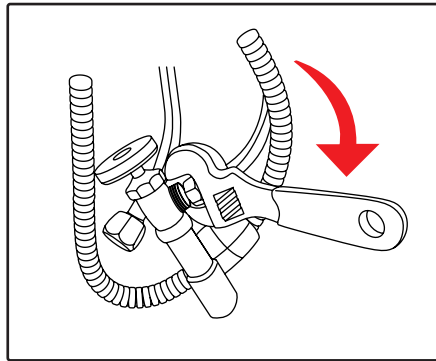

2. Unfasten the cold water line connected raw water valve as like picture.
(Connecting warm water line can be caused trouble.)

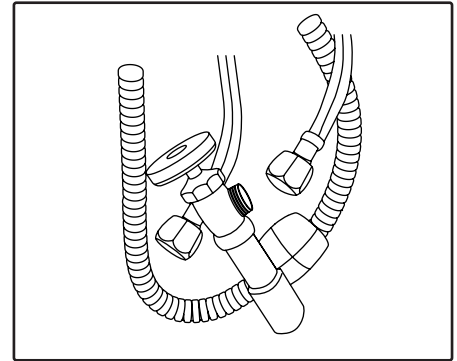

3. Separate the line from valve perfectly.

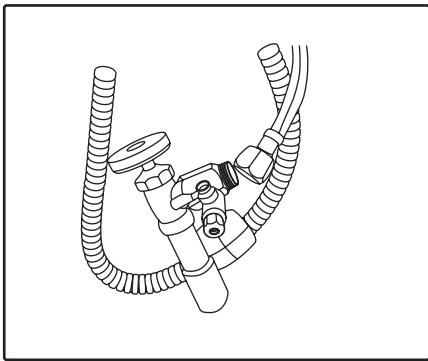

4. Connect the adapter to separated cold water line.

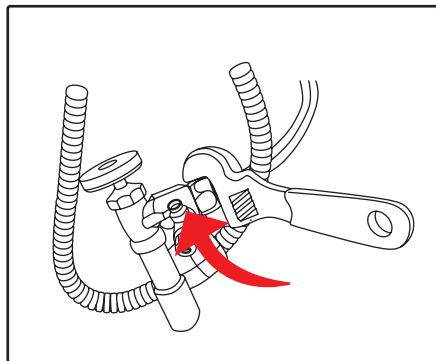

5. Lock the water line perfectly with spanner.
(Locking the valve loose can be caused leaking water.)

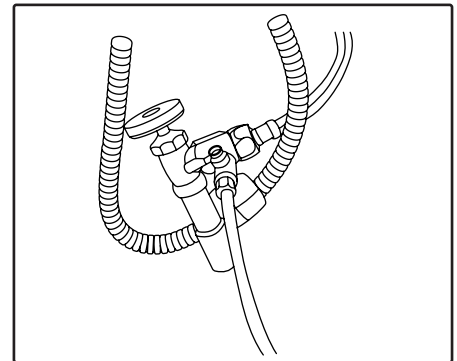

6. Connect tubing as like picture and use the valve on the adapter.
(Connecting warm water line can be caused trouble.)

<Cautions>

- * Locking the valve loose can be caused leaking water.
- * Thinking carefully before installation, the hole for tubing will be pierced on the sink board.
- * Distinguish between cold and warm water lines. Connecting to warm water line can be caused trouble.
- * If leaking generated, lock the valve on the adapter.

8. Place where at your convenience.

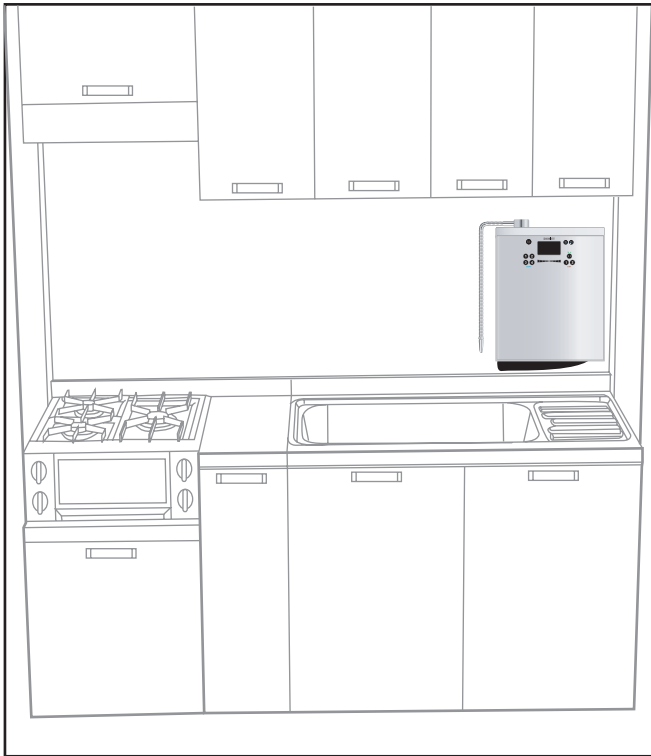

Wall mounting

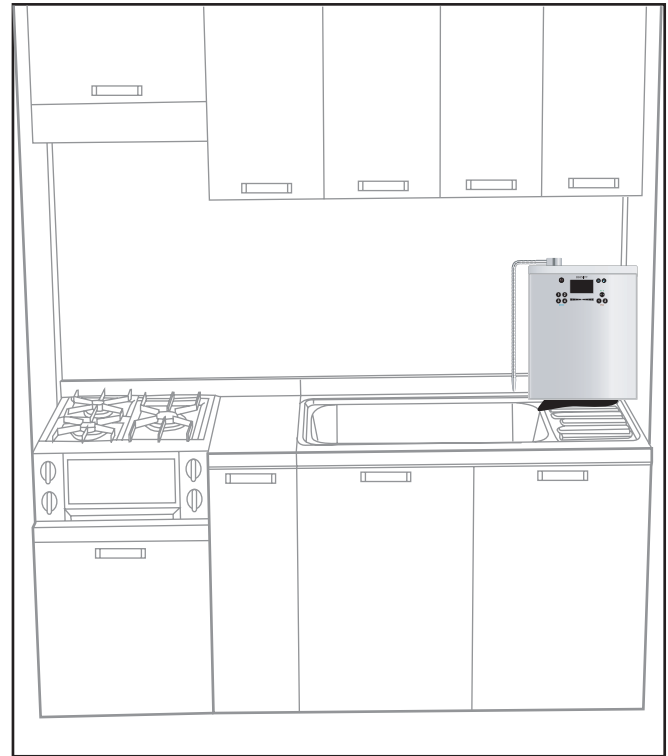

Upon the sink



Warning

Please read this thoroughly for your safety.

Caution during installation

Caution during installation

Check the following matters when installing the main body prior installing.

1. Install at flat and safe place.
2. Ensure that it is not connected to the faucet exclusively for warm water.
3. Do not install at the following places.
 - Installation at the following places often cause malfunction.

Place with vibration and shock	Non-flat place
Place with direct light	Bathroom or place with moisture
Humid and/or dusty place	Place where the product may freeze
Place where heat is used	Other places that may cause other problems

※Specialized technician needs to install the product. If installed by the consumer, resulting problem will not be covered by the warranty.

Extraction Method

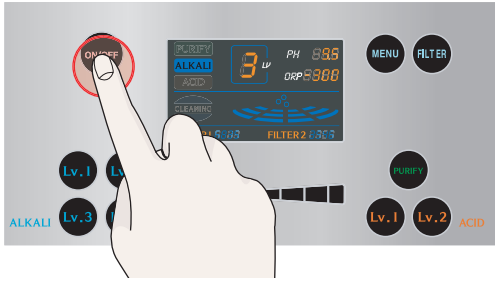

1. Press the main water flow button on top of the product.
2. Select the water type – Alkaline, Acidic, or Purified setting.



3. When the “Alkaline” is selected, the LCD indicates the Alkaline setting and level.

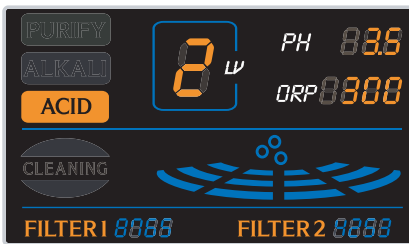

4. Cleaning first blow, please confirm with production of ionized water.



Notice

(Fig. 1)



(Fig. 2)



When you select the main water flow button while the water pressure is low or valve is closed, the LCD will appear as “Fig. 1” Please check the water pressure or valve opening before proceeding.

When leaking water from solenoid valve after main power is screened, the LCD will appear as "Fig.2"

Method for drinking alkali water and cautions

Alkaline Water Usage Guide

1) If the machine has not been used for several days, let the water run on the "Purified Water" setting for at least 1–3 minutes before any operation

2) Users who are not familiar with this water are recommended to start with alkaline water level 2 and adjust the quantity/level of water which might fit you the best. Increase slowly over time as your body adjusts

*Level 2–3 is recommended for first time alkaline ionized water drinkers

3) Store alkaline water in an airtight glass container and put it in a refrigerator for no longer than 2 day for maximum benefit

4) Such water is not drinkable– DO NOT DRINK

1) Use acid water only for disinfecting, cleaning, plants and as a face/skin toner

2) Acidic water properties are the best 1–7 days after ionization if it is put in an airtight glass container and kept in the refrigerator.

Purified Water Usage Guide

1) Clean water is chlorine-free due to the internal ionizer filters and ionizer pre-filter(s)

2) It is best to drink purified water when taking medicines and pills

Alkaline Water Usage

	When using during the first seven days			When using during every day		
	Child	Adult	Note	Child	Adult	Note
Alkaline water	pH7.5	pH7.5~8.5	2~3 cups /day	pH7.5~8.5	pH8.5	
Acidic water	pH5.5	pH5.5	Better if warmed	pH5.5	pH5.5	Better if warmed

* Drinking one to two glasses in the morning on empty stomach and one to two glasses before sleeping are good for your health.

* Alkaline water is about pH 7.5~8.5. Drink one to two glasses per day. If there is no problem after drinking for about one week (7 days), select the stage that suits your make-up to drink at least 10 glasses (2,000cc~3,000cc). Drinking more is good for your health.

Internal Filter Replacement

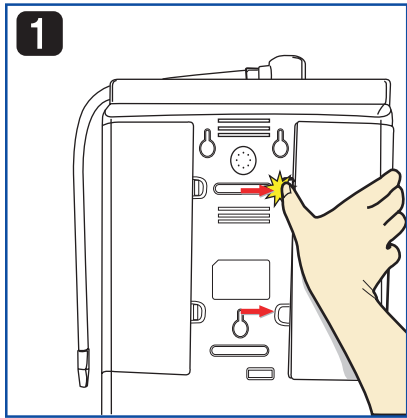

1. Press the top and bottom of the filter cover.

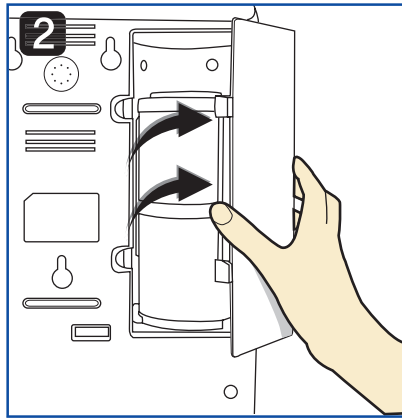

2. Open the filter cover following the direction of the arrow.

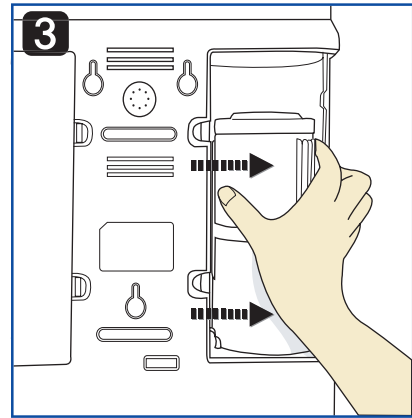

3. Turn the filter top in the arrow direction.

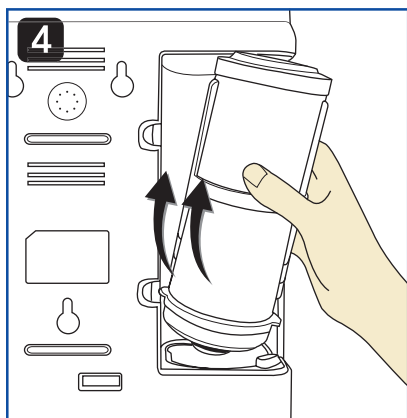

4. Lift the filter up and out following the direction of the arrow.



5. Insert the new filter following the direction of the installation arrow and turn the filter bases appropriately.

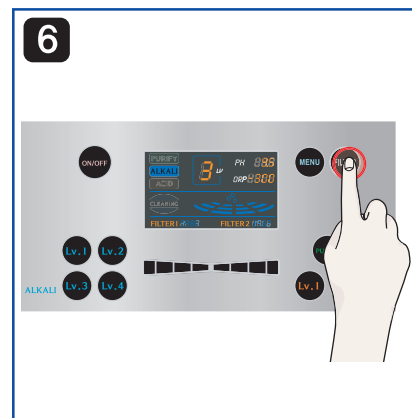

6. Reset the new filter button on the ionizer.

Tips After Filter Replacement:

- 1) Select the "Purified Water" setting and let the water run for 3-5 minutes after any filter replacement .
- 2) If the machine has not been used for a few days, let the water run for 1-3 minutes at the "Purified Water" setting before making Ionized Alkaline water for consumption.
- 3) Consult with the installer or retailer on the purchase of filters if in question about usage or installation.

Filter

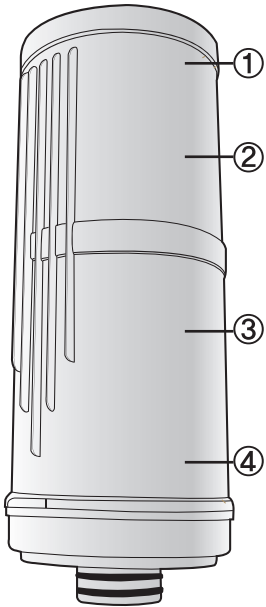

First Filter: Filter A

1. Sediment

Eliminates sediments (mud, rust, sand, etc) 10 microns or larger.

2. Pre-Carbon

Absorbs and eliminates various compounds, remaining chlorine, taste and odor, THM, etc.

3. Activated Carbon Filters

Ultra-fine coconut shell carbon and silver impregnated carbon.

4. Final Stage Sediment Filter

Reduces filter remnants and remaining sediments.

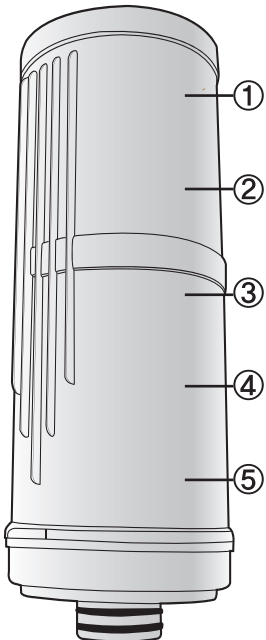

Second Filter: Filter B

1. Granule type Carbon Filter

Reduces chlorine taste and odors, fast absorbing, generates low dust.

2. Pi-Ceramic Negative Ion Filter

Generates negative ions, making water clusters smaller.

3. BioMass ball-Ceramic Filter - High quality ceramic filter designed for bacteria control.

4. Calcium Powder with Ultra Membrane

Transforms structure to hexagonal water.

5. Special Quality Sediment Filter

Prevents sediment discharge.

<Matters to know>

There are instances in which sediment and carbon filter are required separately depending on the place of use or region. In particular, filter for ground water needs to be installed separately for the ground water.

Filter's life time may be different depending on the region and water quality. Thus, replacement of filter when the water taste changes or amount of flux is decreased considerably is recommended.

Common Problems and Solutions

- Check the following before requesting A/S.
An overhaul of the machine should be operated only by authorized personnel.

Condition	Possible Problem	Solutions
The power light is not on.	Check if the power plug and outlet is plugged correctly	Plug in correctly
The switch does not seem to work	<ul style="list-style-type: none"> · Check to see if the power plug and outlet are plugged-in correctly and/or · Check if the fuse on the back is connected 	<ul style="list-style-type: none"> · Insert plug correctly and /or · Check the fuse and if it does not seem to be working properly, replace the fuse
Water doesn't come out or production volume is changed, or changed to filtering, or the machine suddenly stops working	<ul style="list-style-type: none"> · Check if the valve for hot water is turned off · Check if the water hose is connected. · Check if the hose is folded. · Check if the water pressure is too low · Check if the hose is frozen or disconnected · Check if the filter isn't blocked 	<ul style="list-style-type: none"> · Turn on the valve. · Connect the hose correctly. · Stop the operation. · Wait until the water comes out. · Replace the filter. · After spotting water leakage from ion water machine, turn off the water valve and contact the customer service center
Hose is leaking at the joint	Is the hose joint lose?	Connect the hose correctly
The concentration of alkaline water is too low	<ul style="list-style-type: none"> · Check if the concentration of alkali water is set to a low setting · Check if the water is not overflowing. 	Connect the hose correctly
Water has a distinct odor and taste	<ul style="list-style-type: none"> · Check the most recent date of usage – may need to replace filters if ionizer is sitting more than 2 weeks 	<ul style="list-style-type: none"> · Let the water run through the ionizer for more than 3 minutes. If the problem still exists, replace the filters

Common Problems and Solutions

Condition	Possible Problem	Solutions
Filter replacement warning lamp is still on even after replacement.	Check if the filter has been reset.	Reset the filter button on the ionizer
Machine makes a strange sound.		· Stop operation and contact the customer service center
It suddenly stops producing alkali/acid water and power is turned off.	Check if the water source rate too small or suddenly off	Open the water valve or replace the filter.

Matters to check during use

Symptom	Explanation
Bubble results in water color when cathode water is poured into car.	When ion is generating, Cathode water particle is very few. Thus, this phenomenon results when there is a large amount of Dissolved Hydrogen. This may result in large quantity after installation or after replacing filter. But there is no problem in using the product.
When the cathode water is left in a container, there are many instances in which white substance is formed or when it precipitated on the floor. (This is a phenomenon that does not occur frequently in purified water. Degree of manifestation may aggravate since electrolytic ion separation may take place when there are considerable minerals in the water or when there is significant amount of Co_3 , which in turn vitalizes this phenomenon. Thus, use by adjusting the pH stage to suit the water quality.)	This is the phenomenon that results when large amount of calcium mineral substance is contained in the cathode water. In particular, when there is considerable amount of co_3 , Calcium Carbonate (CO_3) is extracted by combining with calcium. This is a sure proof that the electrolytic is taking place. Although drinking it is no problem, please clean the container. Dilute one spoon of vinegar in the container where the water is stored, and fill the water. Leave the water for one hour, and cleanse the container by shaking it, and Calcium Carbonate disappears.

Product specs

Product name		Medicinal substance-producing equipment
Type name		Dion SENSE
Form of protection and grade		Class 2 device, Type B device
Rated power		AC220V/60Hz
Water supply method		Direct tap water
Main body	Measurement	288×354×144(W×H×D)mm
	Weight	5Kg
Usable water pressure		0.7~5.0Kgf/cm ²
Usable temperature		5~30℃
Excessive protective device		Built-in temperature sensor
Electrolytic device	Electrolytic method	Continuous electrolytic method
	Generation capability	2.5l/minute (when the water pressure is 2kgf/cm ²), "cathode water, Acidic water included"
	Electrolytic stage	Alkaline water: Stage 4/astringent: Stage 2/clean water
	Electrolytic cleansing	Automatic cleansing (method of cleansing beforehand)
	Electrode	Platinum electrode
Water purification device	Filter replacement	Cartridge method
	Filter's lifetime	1st 2500l, 2nd 5000l
	Indicating lifetime	Indication of LCD filter's lifetime with text, voice notification
	filter material	Non-woven fabric, purified high end carbon, silver contained activated carbon, Calcium Sulfite
Effect		Device that subjects water to electronic dissolution to generate Alkaline water
Permit for production		
Permitted product category		

